

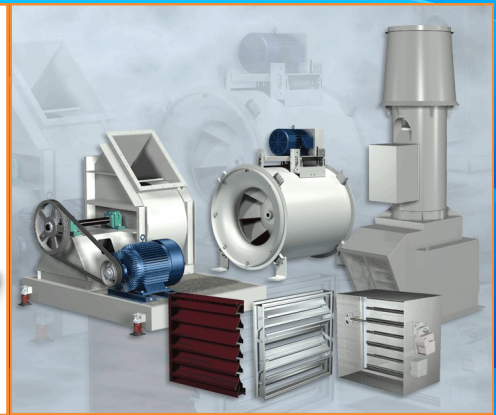

# Air Control Products, Inc.

## Stock Catalog 2019



Columbus

Cleveland

Toledo

**Partnering with You:  
Delivering Solutions and Service**  
Established 1975

**Columbus**  
1201 Essex Avenue  
Columbus, Ohio 43201  
P 614-299-1747  
F 614-299-1301

**Cleveland**  
3800 Towpath Road  
Cleveland, Ohio 44147  
P 440-526-3020  
F 440-526-0503

**Toledo**  
2164 Tedrow Road  
Toledo, Ohio 43614  
P 419-380-8990  
F 419-380-8998

[www.aircontrolproducts.com](http://www.aircontrolproducts.com)



# Air Control Products, Inc.

## Stock Order Form

www.aircontrolproducts.com

Bill to: \_\_\_\_\_ Bill To P.O. # \_\_\_\_\_

\_\_\_\_\_ Date \_\_\_\_\_

\_\_\_\_\_ ACP S.O. # \_\_\_\_\_

\_\_\_\_\_ Terms Net 30 Days

Ship To: \_\_\_\_\_ F.O.B. Standard

\_\_\_\_\_ Req. Ship Date \_\_\_\_\_

\_\_\_\_\_ Ship Via \_\_\_\_\_

- Original Order  
 Confirming Order

Mark/Tag: \_\_\_\_\_

Qty	Part Number	Description	Unit Price	Total Price

Cleveland Warehouse P 440-526-3020 F 440-526-0503  
Columbus Warehouse P 614-299-1747 F 614-299-1301  
Toledo Warehouse P 419-380-8990 F 419-380-8998

\_\_\_\_\_  
Signature

\_\_\_\_\_  
Company Name

**WE ACCEPT: American Express - MasterCard - Visa**



# Air Control Products, Inc.

## Stock Order Form

www.aircontrolproducts.com

Bill to:	Bill To P.O. #	_____
_____	Date	_____
_____	ACP S.O. #	_____
_____	Terms	<u>Net 30 Days</u>
Ship To:	F.O.B.	<u>Standard</u>
_____	Req. Ship Date	_____
_____	Ship Via	_____
_____	<input type="checkbox"/> Original Order	
_____	<input type="checkbox"/> Confirming Order	

Mark/Tag: \_\_\_\_\_

Qty	Part Number	Description	Unit Price	Total Price

Cleveland Warehouse P 440-526-3020 F 440-526-0503  
 Columbus Warehouse P 614-299-1747 F 614-299-1301  
 Toledo Warehouse P 419-380-8990 F 419-380-8998

\_\_\_\_\_ Signature  
 \_\_\_\_\_ Company Name

**WE ACCEPT: American Express - MasterCard - Visa**



# Air Control Products, Inc.

## Cleveland Headquarters Key Contact List

Name	Position	Extension	E-Mail Address
Robert Greene	Chief Executive Officer	220	<a href="mailto:bg@aircontrolproducts.com">bg@aircontrolproducts.com</a>
Mike Greene	President	250	<a href="mailto:mg@aircontrolproducts.com">mg@aircontrolproducts.com</a>
Brandon Burgett	Customer Relations Specialist	240	<a href="mailto:bb@aircontrolproducts.com">bb@aircontrolproducts.com</a>
Joe Charnigo	Account Sales Representative	360	<a href="mailto:jc@aircontrolproducts.com">jc@aircontrolproducts.com</a>
Greg Cobb	Account Sales Representative	310	<a href="mailto:gc@aircontrolproducts.com">gc@aircontrolproducts.com</a>
Kyle Cobb	Account Sales Representative	155	<a href="mailto:kc@aircontrolproducts.com">kc@aircontrolproducts.com</a>
Christine Davis	Customer Relations Specialist	180	<a href="mailto:cd@aircontrolproducts.com">cd@aircontrolproducts.com</a>
Douglas DiLillo	Marketing Manager	165	<a href="mailto:douglas@aircontrolproducts.com">douglas@aircontrolproducts.com</a>
Lauren Estes	Customer Relations Specialist	260	<a href="mailto:le@aircontrolproducts.com">le@aircontrolproducts.com</a>
Jon Frank	Account Sales Representative	145	<a href="mailto:jf@aircontrolproducts.com">jf@aircontrolproducts.com</a>
Alex Hallman	Customer Relations Specialist	270	<a href="mailto:alex@aircontrolproducts.com">alex@aircontrolproducts.com</a>
Janet Heuser	Office Manager	300	<a href="mailto:janet@aircontrolproducts.com">janet@aircontrolproducts.com</a>
Jackie Hill	Senior Accountant	115	<a href="mailto:jackie@aircontrolproducts.com">jackie@aircontrolproducts.com</a>
Lauren Jennings	Project Coordinator	110	<a href="mailto:lauren@aircontrolproducts.com">lauren@aircontrolproducts.com</a>
Robert Kane	Account Sales Representative	330	<a href="mailto:bk@aircontrolproducts.com">bk@aircontrolproducts.com</a>
Adam Koehler	Warehouse Manager	350	<a href="mailto:adam@aircontrolproducts.com">adam@aircontrolproducts.com</a>
Sean Lacy	Mechanical Engineer Co-op	433	<a href="mailto:sean@aircontrolproducts.com">sean@aircontrolproducts.com</a>
Robert Laneve	Director of Engineering	380	<a href="mailto:rl@aircontrolproducts.com">rl@aircontrolproducts.com</a>
Lou Maglione	Chief Financial Officer	370	<a href="mailto:lou@aircontrolproducts.com">lou@aircontrolproducts.com</a>
Beth Marano	Accounts Payable Coordinator	340	<a href="mailto:beth@aircontrolproducts.com">beth@aircontrolproducts.com</a>
Ben Mey	Account Sales Representative	411	<a href="mailto:ben@aircontrolproducts.com">ben@aircontrolproducts.com</a>
Marcia Nescola	Receptionist	120	<a href="mailto:marcia@aircontrolproducts.com">marcia@aircontrolproducts.com</a>
Dan Paulitzky	Customer Relations Specialist	210	<a href="mailto:dan@aircontrolproducts.com">dan@aircontrolproducts.com</a>
Cece Reilly	Customer Relations Specialist	230	<a href="mailto:cece@aircontrolproducts.com">cece@aircontrolproducts.com</a>
Brian Rhodes	Account Sales Representative	200	<a href="mailto:br@aircontrolproducts.com">br@aircontrolproducts.com</a>
Brandon Scott	Architectural Product Manager	160	<a href="mailto:brandon@aircontrolproducts.com">brandon@aircontrolproducts.com</a>
Anmarie Szczesniak	Accounts Receivable Coordinator	100	<a href="mailto:annemarie@aircontrolproducts.com">annemarie@aircontrolproducts.com</a>
Brittany Welsh	Architectural Sales	170	<a href="mailto:bw@aircontrolproducts.com">bw@aircontrolproducts.com</a>
Christine Wenning	Customer Relations Specialist	280	<a href="mailto:chris@aircontrolproducts.com">chris@aircontrolproducts.com</a>
Mike Williams	Customer Relations Specialist	290	<a href="mailto:mw@aircontrolproducts.com">mw@aircontrolproducts.com</a>
Evan Winfield	Warehouse		





# Air Control Products, Inc.

## Columbus Headquarters Key Contact List

Name	Position	Extension	E-Mail Address
Robert Greene	Chief Executive Officer	220	<a href="mailto:bg@aircontrolproducts.com">bg@aircontrolproducts.com</a>
Mike Greene	President	250	<a href="mailto:mg@aircontrolproducts.com">mg@aircontrolproducts.com</a>
Jason Treacy	Columbus Branch Manager	445	<a href="mailto:jason@aircontrolproducts.com">jason@aircontrolproducts.com</a>
Kevin Brauchi	Account Sales Representative	426	<a href="mailto:kevinb@aircontrolproducts.com">kevinb@aircontrolproducts.com</a>
Tristen Brown	Customer Relations Specialist	430	<a href="mailto:tristenb@aircontrolproducts.com">tristenb@aircontrolproducts.com</a>
Jason Bush	Estimator / Inside Sales	424	<a href="mailto:jasonb@aircontrolproducts.com">jasonb@aircontrolproducts.com</a>
Mike Gersper	Account Sales Representative	410	<a href="mailto:mikeg@aircontrolproducts.com">mikeg@aircontrolproducts.com</a>
Mike Hoffa	Account Sales Representative	431	<a href="mailto:mikeh@aircontrolproducts.com">mikeh@aircontrolproducts.com</a>
Steve Janutolo	Account Sales Representative	455	<a href="mailto:stevej@aircontrolproducts.com">stevej@aircontrolproducts.com</a>
Jess Myers	Account Sales Representative	450	<a href="mailto:jessm@aircontrolproducts.com">jessm@aircontrolproducts.com</a>
Jon Pierce	Warehouse & Parts Manager	460	<a href="mailto:jonp@aircontrolproducts.com">jonp@aircontrolproducts.com</a>
Tammy Smith	Architectural Sales	420	<a href="mailto:tammys@aircontrolproducts.com">tammys@aircontrolproducts.com</a>
Glen Sweeney	Account Sales Representative	440	<a href="mailto:glens@aircontrolproducts.com">glens@aircontrolproducts.com</a>
Amanda Worrix	Customer Relations Specialist	415	<a href="mailto:amandaw@aircontrolproducts.com">amandaw@aircontrolproducts.com</a>
Chris Whicker	Application Engineer	400	<a href="mailto:chrisw@aircontrolproducts.com">chrisw@aircontrolproducts.com</a>

## Toledo Headquarters Key Contact List

Name	Position	Extension	E-Mail Address
Robert Greene	Chief Executive Officer	220	<a href="mailto:bg@aircontrolproducts.com">bg@aircontrolproducts.com</a>
Mike Greene	President	250	<a href="mailto:mg@aircontrolproducts.com">mg@aircontrolproducts.com</a>
Chuck Barlage	Toledo Branch Manager	517	<a href="mailto:chuck@aircontrolproducts.com">chuck@aircontrolproducts.com</a>
Anthony Drouillard	Customer Relations Specialist	510	<a href="mailto:anthony@aircontrolproducts.com">anthony@aircontrolproducts.com</a>
Mark Michalak	Account Sales Representative	515	<a href="mailto:mark@aircontrolproducts.com">mark@aircontrolproducts.com</a>
Andrew Moses	Engineering Sales	511	<a href="mailto:andrew@aircontrolproducts.com">andrew@aircontrolproducts.com</a>
Phil Westrick	Account Sales Representative	512	<a href="mailto:phil@aircontrolproducts.com">phil@aircontrolproducts.com</a>

The acceptance of any order by Air Control Products, Inc. ("ACP") from the buyer referenced on the face hereof or attached hereto (the "Buyer"), and/or Buyer's acceptance of the equipment and merchandise referenced on the face hereof or attached hereto (the "Equipment") constitutes Buyer's acceptance of all of terms and conditions contained herein. Any inconsistent or additional terms contained in the Buyer's purchase order are hereby rejected. The terms and conditions as stated herein shall not be modified other than in writing signed by ACP and Buyer.

**1. Prices:**

All prices for the Equipment are subject to change without notice. Equipment will be billed at the prices in effect at time of shipment and are F.O.B. original shipping point. Prices do not include applicable federal, state and/or local taxes. Minimum order size is \$25.

**2. Terms:**

The obligation of ACP to fulfill any Buyer order in accordance with these terms and conditions is conditioned upon Buyer paying in full the purchase price for all Equipment related to the order. Unless otherwise agreed to by ACP, payment of the full purchase price for the Equipment, plus taxes and freight where applicable, shall be due net thirty (30) days from the date of invoice (the "Payment Term") with a service charge of one and one-half percent (1 ½%) of the invoiced amount applying to the unpaid balance for each month, or fraction thereof, for invoices not paid in full after thirty days. A three percent (3%) service charge will be added to any payments made by credit card on balances beyond the Payment Term. Past due accounts could be placed on hold, could have intent to lien letters sent, or liens filed at ACP's discretion. If, in the sole discretion of ACP, Buyer's credit is impaired at anytime, ACP shall have the right, without incurring any liability, to change the terms of payment, stop shipment, and/or cancel any order.

**3. Title and Risk of Loss:**

Title in and risk of loss for all Equipment sold hereunder shall pass to Buyer upon delivery to carrier F.O.B. ACP's facility or ACP's supplier, as applicable.

**4. Cancellation, Return, Change Orders, Delivery:**

ACP is entitled to rely upon the receipt of either a written purchase order or email acknowledgement from Buyer in sufficient detail to enable it to fulfill any order. No orders may be withdrawn, canceled or returned by Buyer, nor may they be deferred when ready, unless ACP shall have approved such withdrawal, cancellation, return or deferral in writing and ACP shall have been paid a withdrawal, cancellation, return or deferral charge of a reasonable amount acceptable to ACP. In the event Buyer shall request changes in its order after receipt thereof by ACP, it shall be responsible for all charges reasonably incurred by ACP with respect to such changes. Only ACP stock Equipment inventory will be considered for return. No special order items may be returned under any circumstances. In the event ACP agrees to a return of stock Equipment inventory, all such Equipment shall be returned within thirty (30) days of delivery in new condition and in its original packaging and containers. All accepted returns are subject to a twenty-five percent (25%) restocking and/or handling fee. All accepted returns must include a copy of the original sales order, and a complete return goods authorization form. Any dates or schedules which may be specified for the delivery of the Equipment have been stated only approximately and are estimated from the date of release of Buyer's order, with complete specifications, designs, samples and other information reasonably requested by ACP. ACP shall not incur any liability, either direct or indirect, nor shall any order be canceled, because or as a result of any delays in meeting such dates or schedules. ACP shall not be responsible or liable for any delays or failures in manufacture or delivery due to any cause or condition beyond the control of ACP including, without limitation, strikes or labor difficulties, fire, floods, inability to secure transportation facilities, actions of the elements, shortage of materials or equipment, riots or other civil commotions, acts of God and war. ACP is not responsible for any delays caused by third party suppliers of ACP or the inability of any such third parties to deliver their goods. It is understood by Buyer that ACP's quote may be based on a quote from a third party and ACP shall not be bound by its own quote if any third party fails to provide its goods or services as agreed.

**5. Limited Warranty:**

ACP makes no warranty whatsoever, except as to title, with respect to the Equipment. All Equipment is sold with the understanding that Buyer has independently determined the suitability or compatibility of such Equipment for its purposes. Any statements, technical information or recommendations concerning Equipment sold by ACP are based upon data provided to ACP by its suppliers and believed to be accurate, but do not constitute a guarantee or warranty.

Buyer's sole remedy for damaged or defective Equipment shall be through any warranty provided by the manufacturer of the Equipment (which will be made available upon request) and/or a claim against the shipper. All cartons/Equipment must be inspected and any damage claim must be reported within forty-eight (48) hours of delivery. ACP will use commercially reasonable efforts to assist Buyer in pursuing warranty claims with the manufacturer of the Equipment and resolving any claim for damages and/or losses in transit with the shipper.

**EXCEPT FOR THE EXPRESS WARRANTY AS DESCRIBED ABOVE, THERE ARE NO OTHER WARRANTIES OR GUARANTEES, EITHER EXPRESS OR IMPLIED, WRITTEN, ORAL OR ARISING UNDER CUSTOM OF TRADE INCLUDING, WITHOUT LIMITATION, THE WARRANTIES OF MERCHANTABILITY AND FITNESS FOR ANY PARTICULAR PURPOSE. NO WARRANTIES OR REPRESENTATIONS AT ANY TIME MADE BY ANY REPRESENTATIVE OF ACP SHALL BE EFFECTIVE TO VARY OR EXPAND THE ABOVE-REFERENCED EXPRESS WARRANTY OR ANY TERMS HEREOF.**

**6. Limitation of Liability:**

In no event shall ACP be liable to Buyer or to any third party for consequential, incidental or special damages, or for lost profits, resulting from or in any manner related to the Equipment, its delivery, non-delivery, design, use, or any inability to use the same, whether such damages be claimed under contract, tort or any other legal theory. Buyer understands that the sole and exclusive remedies of Buyer are those set forth in Section 5 hereof. ACP's liability hereunder shall not exceed the purchase price of the Equipment that fails to meet ACP's warranty of title. This limitation of liability shall survive the termination, expiration or cancellation of these terms and conditions.

**7. Indemnification:**

Buyer shall indemnify, defend and hold harmless ACP against all claims, loss, liability and expense (including, without limitation, reasonable attorneys' fees) on account of: (A) any damaged property or injury or death of persons (including, without limitation, Buyer's employees) arising out of Buyer's unloading, storage, handling, use or disposal of the Equipment, or (B) Buyer's breach of these terms and conditions. This indemnity obligation of Buyer will survive the expiration, termination or cancellation of these terms and conditions.

**8. General:**

A. Repairs to Equipment may be done by ACP as mutually agreed by the parties. All repairs made by ACP are on an F.O.B original shipping point basis and transportation charges on Equipment returned for repairs must be prepaid.

B. If ACP initiates action or incurs any cost, fee, or expense in enforcing its rights hereunder, including, without limitation, Buyer's payment obligations (the "Enforcement Costs"), then Buyer agrees to reimburse ACP upon demand for such Enforcement Costs. The Enforcement Costs shall include, but not be limited to, court costs and attorneys' fees incurred by ACP in enforcing its rights.

C. There are no understandings between the parties as to the subject matter of these terms and conditions and the related transaction other than as set forth herein. All previous communications between the parties concerning the subject matter hereof, whether verbal or written, are abrogated and withdrawn, and these terms and conditions constitute the whole of the agreement between the parties.

D. These terms and conditions shall be determined and construed in accordance with, and shall be governed by, the laws of the State of Ohio. The parties agree that the United Nations Convention of Contracts for the International Sale of Goods will not apply to these terms and conditions. Further, Buyer and ACP agree that the exclusive jurisdiction for purposes of resolving any dispute or claim arising in connection herewith shall be the local, state or federal courts within Cuyahoga County, Ohio.

E. Nothing in these terms and conditions shall be construed as creating any act or beneficial right in or on behalf of any third party.

F. The failure of either party to insist or enforce in any instance strict performance of these terms and conditions or to exercise any rights hereunder conferred, shall not be construed as a waiver or relinquishment to any extent of its right to assert or rely upon such terms or rights on any future occasion.

G. In the event Buyer seeks to make payment in an amount less than the full amount of the invoice and Buyer intends such payment to be in full satisfaction of the invoice, Buyer must send such payment to Air Control Products, Inc., 3800 Towpath Road, Broadview Heights, Ohio 44147, Attention: President.

## Air Distribution

# Table of Contents

### Diffusers

Model #	Description	Page
SCD/SCDA	Square Cone and Square Cone Adjustable Diffusers	1
SPD	Square Plaque Diffusers	2
SMD	Louvered Face Directional Diffusers	3
SCVD	Curved Vane Diffusers	4
RCDE	Round Cone Diffusers	4
16	Round Ceiling Diffusers	5
12	Round Damper with Ring	5
3800	Damper without Ring	5
PDF/3	Perforated Supply Diffusers	6
PDC	Perforated Supply Diffusers (Individual Adj. Blades)	6
PDDR/3	Perforated Return Diffusers	7
PDMC/3	Modular Core Diffusers	7
DCD	Two Slot Diffusers	16
J	Slot Diffusers	16
SDS Series	Slot Diffusers	16
VPD-HC	Varitherm - Thermally Powered VAV Diffusers	17



### Grilles & Registers

520D	Double Deflection Louvered Supply Register w/Damper	8
10	Perforated Face Return Grilles	10
530	Louvered Return Grilles	9
530FF	Louvered Face Filter Return Grilles	10
RGS-3	Registers for Spiral Duct	11
RAC	Return Air Canopy	11
80	Eggcrate Face Return Grilles	12



### Air Distribution Accessories

VCR 9	Radial Shutter Dampers	12
PFRF	Perforated Return Panel	12
VCS3	Opposed Blade Dampers	12
AMF/SPF	Aluminum Surface Mount Adapter Frames	12
Grid	Round Equalizing Grids	12
DCD Frame	Surface Mount Frames	16

### VAV Boxes

SDV	Single Duct Terminal Unit (Bare Box)	13
SPD	Single Duct Terminal Units with Pneumatic Controls	13

### VAV Accessories

Coil	Two Row Hot Water Coils	14
CP101	Pneumatic Controller	14
MCP	Actuator	14

### Motorized Dampers

RDV	Round VVT, VAV and Shut Off Dampers	15
Dampers & Motors	Spring Return Round Dampers	15

### Spiral Pipe, Fittings & Pipe Access Doors

#### Spiral Pipe, Fittings & Accessories

Pipe	Spiro Safe Spiral Pipe	18
BSU 90°/BSFU 90°	90° Elbows	19
BSU 45°/BSFU 45°	45° Elbows	20
NPU/MF	Couplings/Connectors	21
ESU	End Caps	22
TCPU	Tees	22
RCU/RCLU	Reducers	23
PSU	Saddle Taps	24
PSVU	Saddle Taps	25
ILU/ILRU	Take Offs	26
DSU	Dampers	26
HF	Gripple Loop & Stud End Hangers	27
JFWRC / HF Set	Gripple Cutting Tool	27
		28
Access Door	Wall Pipe Access Door	29
9TM/FDH	Drywall Access Door & Framed Access Doors	30



## Air Distribution

# Table of Contents

### Diffusers

Model #	Description	Page
SCD/SCDA	Square Cone and Square Cone Adjustable Diffusers	1
SPD	Square Plaque Diffusers	2
SMD	Louvered Face Directional Diffusers	3
SCVD	Curved Vane Diffusers	4
RCDE	Round Cone Diffusers	4
16	Round Ceiling Diffusers	5
12	Round Damper with Ring	5
3800	Damper without Ring	5
PDF/3	Perforated Supply Diffusers	6
PDC	Perforated Supply Diffusers (Individual Adj. Blades)	6
PDDR/3	Perforated Return Diffusers	7
PDMC/3	Modular Core Diffusers	7
DCD	Two Slot Diffusers	16
J	Slot Diffusers	16
SDS Series	Slot Diffusers	16
VPD-HC	Varitherm - Thermally Powered VAV Diffusers	17



### Grilles & Registers

520D	Double Deflection Louvered Supply Register w/Damper	8
10	Perforated Face Return Grilles	10
530	Louvered Return Grilles	9
530FF	Louvered Face Filter Return Grilles	10
RGS-3	Registers for Spiral Duct	11
RAC	Return Air Canopy	11
80	Eggcrate Face Return Grilles	12



### Air Distribution Accessories

VCR 9	Radial Shutter Dampers	12
PFRF	Perforated Return Panel	12
VCS3	Opposed Blade Dampers	12
AMF/SPF	Aluminum Surface Mount Adapter Frames	12
Grid	Round Equalizing Grids	12
DCD Frame	Surface Mount Frames	16

### VAV Boxes

SDV	Single Duct Terminal Unit (Bare Box)	13
SPD	Single Duct Terminal Units with Pneumatic Controls	13

### VAV Accessories

Coil	Two Row Hot Water Coils	14
CP101	Pneumatic Controller	14
MCP	Actuator	14

### Motorized Dampers

RDV	Round VVT, VAV and Shut Off Dampers	15
Dampers & Motors	Spring Return Round Dampers	15

### Spiral Pipe, Fittings & Pipe Access Doors

#### Spiral Pipe, Fittings & Accessories

Pipe	Spiro Safe Spiral Pipe	18
BSU 90°/BSFU 90°	90° Elbows	19
BSU 45°/BSFU 45°	45° Elbows	20
NPU/MF	Couplings/Connectors	21
ESU	End Caps	22
TCPU	Tees	22
RCU/RCLU	Reducers	23
PSU	Saddle Taps	24
PSVU	Saddle Taps	25
ILU/ILRU	Take Offs	26
DSU	Dampers	26
HF	Gripple Loop & Stud End Hangers	27
JFWRC / HF Set	Gripple Cutting Tool	27
		28
Access Door	Wall Pipe Access Door	29
9TM/FDH	Drywall Access Door & Framed Access Doors	30



# Table of Contents

## Snaplock Pipe, Fittings & Sealant

### Pipe, Fittings & Sealant

Model #	Description	Page
1008	Pipe	31
1005	90° Elbows	31
1051	Flat Collars - Crimped	32
1064	Round End Caps	32
1062	Tapered Reducers	32
1066	One Quad Dampers	33
1067	Two Quad Dampers	33
1059	Tee Joints	33
EP13	Adjustable Take Offs	34
1070	Chimney Caps	34
ATDRP	Saddle Taps	34
1057	Storm Collars	35
1071T	Tall Cone Flashings	35
Blast Gates	Blast Gates	35
Duct Sealant	Duct Sealant	29



## Flexible Duct & Sheet Metal Fittings

UPC #50	Uninsulated Flex	36
UPC #70	Insulated Flex	36
UPC #30	Insulate Flex	38
UPC #10	Duct Sleeve	38
Type 8M	Insulated Flex	39
Type 3B	Insulated Flex	39
Type 5M	Low Pressure Insulated Flex	40
Type 3M	Hi Pressure Insulated Flex	40
Type NI-35	Non Insulated Flex	37
KM	Insulated Flex	37



### Sheet Metal Fittings

FLD SOG	Spin in Collar	41
SLD BO3	WalMart Dampers	41
STOD BO 2	Side Take Off w/Damper	42
FLDE-SOG 90	Take off w/Damper & 90° Scoop	42
ATDBMD	Conical Take Off w/Damper	43
F3SO	Square to Round Adapters Open Corners	44
STR	Square to Round Adapters Closed Corners	45

## Bath Fans, Roof & Ceiling Exhaust Fans

### Bath Fans

676	Bathroom Vent Fan 110 CFM	46
679	Bathroom Vent Fan w/Light 70CFM	46
684	Bathroom Vent Fan 80CFM	46
689	Bathroom Ceiling/Wall Vent Fan 60 CFM	46
639, 642, 641, 643,441	Wall Cap	47
636, 613	Roof Cap	47



We Accept:



# Table of Contents

## Snaplock Pipe, Fittings & Sealant

### Pipe, Fittings & Sealant

Model #	Description	Page
1008	Pipe	31
1005	90° Elbows	31
1051	Flat Collars - Crimped	32
1064	Round End Caps	32
1062	Tapered Reducers	32
1066	One Quad Dampers	33
1067	Two Quad Dampers	33
1059	Tee Joints	33
EP13	Adjustable Take Offs	34
1070	Chimney Caps	34
ATDRP	Saddle Taps	34
1057	Storm Collars	35
1071T	Tall Cone Flashings	35
Blast Gates	Blast Gates	35
Duct Sealant	Duct Sealant	29



## Flexible Duct & Sheet Metal Fittings

UPC #50	Uninsulated Flex	36
UPC #70	Insulated Flex	36
UPC #30	Insulate Flex	38
UPC #10	Duct Sleeve	38
Type 8M	Insulated Flex	39
Type 3B	Insulated Flex	39
Type 5M	Low Pressure Insulated Flex	40
Type 3M	Hi Pressure Insulated Flex	40
Type NI-35	Non Insulated Flex	37
KM	Insulated Flex	37



### Sheet Metal Fittings

FLD SOG	Spin in Collar	41
SLD BO3	WalMart Dampers	41
STOD BO 2	Side Take Off w/Damper	42
FLDE-SOG 90	Take off w/Damper & 90° Scoop	42
ATDBMD	Conical Take Off w/Damper	43
F3SO	Square to Round Adapters Open Corners	44
STR	Square to Round Adapters Closed Corners	45

## Bath Fans, Roof & Ceiling Exhaust Fans

### Bath Fans

676	Bathroom Vent Fan 110 CFM	46
679	Bathroom Vent Fan w/Light 70CFM	46
684	Bathroom Vent Fan 80CFM	46
689	Bathroom Ceiling/Wall Vent Fan 60 CFM	46
639, 642, 641, 643,441	Wall Cap	47
636, 613	Roof Cap	47



We Accept:





# Table of Contents



## Roof & Ceiling Exhaust Fans

G & GB	Direct Drive and Belt Drive Roof Exhaust Fans	48
SP	Ceiling Exhaust Fan	49
CSP	Ceiling Exhaust Fan	50

## Accessories Roof & Ceiling Exhaust Fans

WD100	Back Draft Damper	51
SSC-05	Solid State Controller	51
VI Kit	Vibration Isolator Kit	51
ETSRS	Cooling T-Stat	51

## Curbs, Pipe Portal & Equipment Rails

### Curbs, Rails & Pipe Portal Systems

Model #	Description	Page
Curbs	Roof Curb	52
Pipe Portal	Curb Caps, Cover & Alumi-flash	52
Equipment Rails	Straight / Canted	53
Dektites	Dektites	53



## Heaters

### Wall & Baseboard Heaters

3320TTD-RP	Fan Forced Wall Heater	54
2900 Series	Baseboard Heaters	54
5100 Series	Electric Unit Heater	55



## Louvers, Brick Vents, Fire Dampers, Radiation Dampers, & Access Doors

### Louvers & Brick Vents

	Louver	56
BEX	Brick Vent	56

### Dampers & Access Doors

FD150H	Fire Damper	57
FD150	Fire Damper	57
Fusible Links	Fusible Link	57
DFD150	Dynamic Rated Fire & Radiation Dampers	58
CRD2	Round Radiation Damper	58
CRD60	Square Radiation Damper	58
Blanket	Radiation Blanket	58



## Duct Smoke Detectors

### Duct Smoke Detectors

D4120 ACDCI	Duct Smoke Detector and Sampling Tubes	59
APA151	Remote Annunciator with Alarm	59
RTS151Key	Key Remote Test/Reset Station	59
RTS151	Magnetic Test Reset Station	59
RTS2	Key Test Annunciator	59
AOS	Strobe (Fire)	59
PS12/24	Strobe (Smoke)	59



## Draw Bands, Tools, & Eggcrate

Bands & Tools	Draw Bands & Tools	60
Eggcrate	Plastic & Aluminum Eggcrate	60



## Misc. Information

	Loudness	61
	Ventilation	62
	Line Card	
<b>A MUST SEE</b>	<b>Coil Replacement Manual</b>	



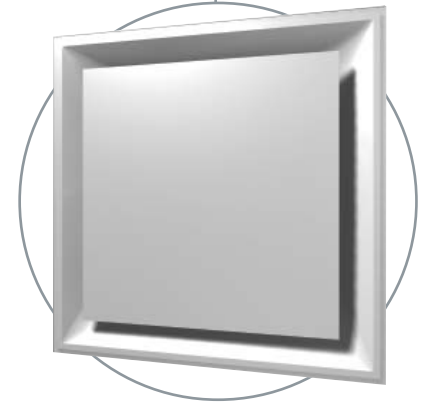
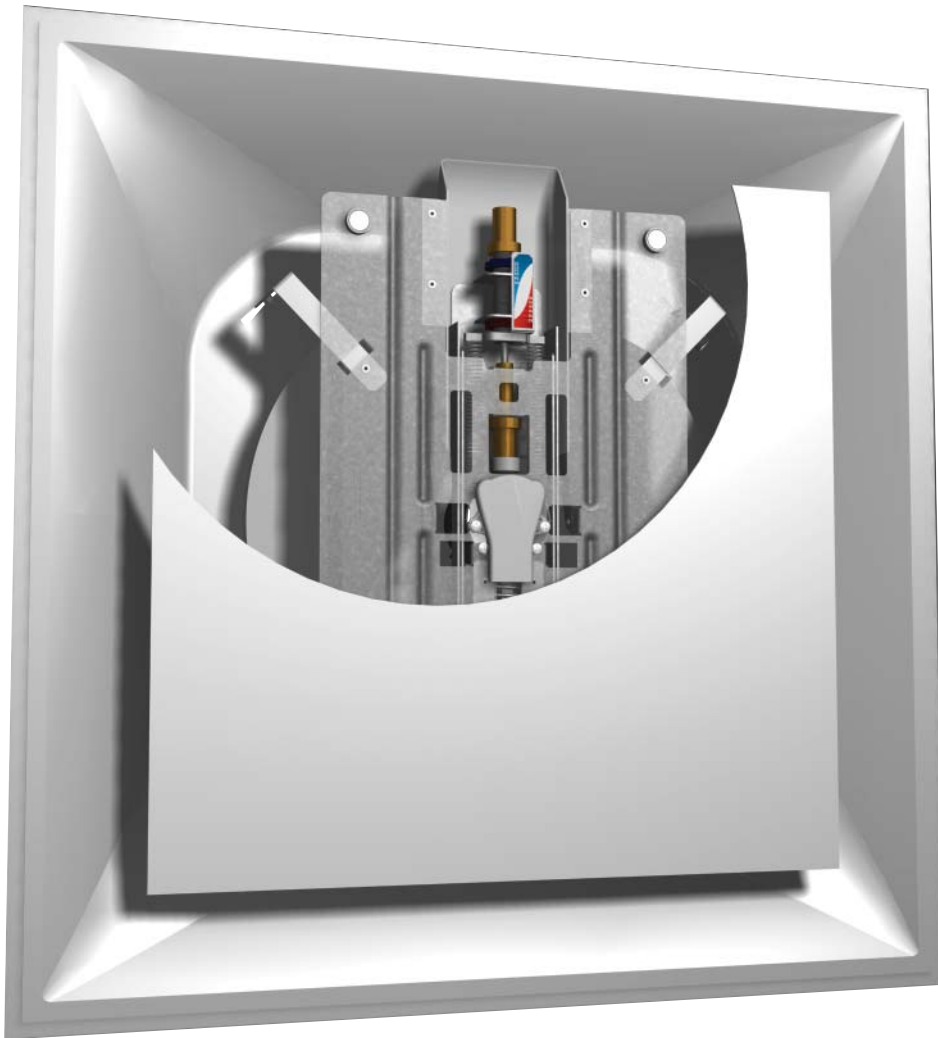

INTRODUCING  
PRICE'S NEW  
THERMALLY  
POWERED  
VAV DIFFUSER...

## ACHIEVE PERSONAL COMFORT

The Price Varitherm® is the most advanced thermally powered VAV diffuser available in the industry today. Using thermal actuators, the Varitherm® provides superior occupant comfort and control by effectively regulating the supply of conditioned air to the space without the use of electric or pneumatic controls.

The Price Varitherm® is an excellent choice for local VAV applications such as offices, boardrooms, and small zones. The Varitherm® can also be used throughout a building as a primary VAV system.

## THE PRICE VARITHERM® OFFERS:

- ▶ Easy installation and operation
- ▶ Individual VAV zone control
- ▶ Room side access of all control adjustments
- ▶ Low pressure drop and quiet operation
- ▶ ARI certified data
- ▶ Heating and cooling, or cooling only models

## Square Ceiling Diffusers

### Model SCD-Square Cone Diffuser

- *Construction: Steel*
- *Finish: White*
- *Cones: One piece die-formed with smooth, aerodynamically designed surfaces and no corner joints. All sizes are available with (3) concentric cones.*
- *Optional fourth cone available in 24" x 24" only.*



ACP Part Number	Inlet Size	Face Size	Cle	Col	Tol
SCD12126	6"	12 x 12	•	•	•
SCD12128	8"	12 x 12	•	•	•
SCD24246	6"	24 x 24	•	•	•
SCD24248	8"	24 x 24	•	•	•
SCD242410	10"	24 x 24	•	•	•
SCD242412	12"	24 x 24	•	•	•
SCD242414	14"	24 x 24	•	•	•
SCD242415	15"	24 x 24	•		•
SCDCONE	4 <sup>th</sup> Cone for SCD 24x24		•		•

### Model SCDA -Square Cone Diffuser Adjustable

- *Construction: Steel*
- *Finish: White*
- *SCDA includes adjustable pattern controllers to provide either a horizontal or vertical air pattern for heating and cooling applications.*
- *Cones: One piece die-formed with smooth, aerodynamically designed surfaces and no corner joints. All sizes are available with (3) concentric cones.*
- *Optional fourth cone available in 24" x 24" only.*

ACP Part Number	Inlet Size	Frame	Face Size	Cle	Col	Tol
SCDA24246	6"	Type 31 Lay-In	24 x 24	•	•	
SCDA24248	8"	Type 31 Lay-In	24 x 24	•		
SCDA242410	10"	Type 31 Lay-In	24 x 24	•	•	
SCDA242412	12"	Type 31 Lay-In	24 x 24	•	•	



### Molded R6 Insulation Panel

- *For square cone and square plaque diffusers*



ACP Part Number	Size	Cle	Col	Tol
INSR6P	24 x 24	•		

## Square Ceiling Diffusers

---

### Model SPD-Square Plaque Diffuser



- *Construction: Steel*
- *Finish: White*
- *Face panel has smooth edges and rounded off corners to blend with back cone.*
- *Back cone is one-piece die-formed with smooth, surfaces and no corner joints. Helps prevent ceiling smudging.*
- *The back cone shape combines with the face panel to delivery a tight 360 degree radial horizontal air pattern.*

ACP Part Number	Inlet Size	Frame	Face Size	Cle	Col	Tol
SPD12126	6"	Type 31 Lay-In	12 x 12	●	●	
SPD12128	8"	Type 31 Lay-In	12 x 12	●	●	
SPD24246	6"	Type 31 Lay-In	24 x 24	●	●	●
SPD24248	8"	Type 31 Lay-In	24 x 24	●	●	●
SPD242410	10"	Type 31 Lay-In	24 x 24	●	●	●
SPD242412	12"	Type 31 Lay-In	24 x 24	●	●	●
SPD242414	14"	Type 31 Lay-In	24 x 24	●	●	
SPD1212Baffle		Baffle for SPD	12 x 12	●		
SPD2424Baffle		Baffle for SPD	24 x 24	●		

## Square Ceiling Diffusers

### Model SMD-Louvered Face Directional Diffuser

- *Construction: Steel    Finish: White*
- *Directional core is easily removable at the diffuser face without requiring special tools.*
- *Optional square to round neck adaptors available.*

#### Frame Style: Surface Mounted - Bevelled

ACP Part Number	Inlet Size	Air Pattern	Cle	Col	Tol
SMD61S66	6 x 6	1 Way	●		
SMD62S66	6 x 6	2 Way	●		
SMD62G66	6 x 6	2 Way Corner	●		
SMD63A66	6 x 6	3 Way	●		
SMD64A66	6 x 6	4 Way	●		
SMD61S99	9 x 9	1 Way	●		
SMD62S99	9 x 9	2 Way	●		
SMD62G99	9 x 9	2 Way Corner	●		
SMD63A99	9 x 9	3 Way	●		
SMD64A99	9 x 9	4 Way	●		
SMDG61S1212	12 x 12	1 Way	●		
SMD62S1212	12 x 12	2 Way	●		
SMD62G1212	12 x 12	2 Way Corner	●		
SMD63A1212	12 x 12	3 Way	●		
SMD64A1212	12 x 12	4 Way	●		
SMD64A1515	15 x 15	4 Way	●		
SMD64A1818	18 x 18	4 Way	●		



#### Frame Style: Lay In Inverted T-Bar

ACP Part Number	Inlet Size	Face Size	Air Pattern	Cle	Col	Tol
SMD3P1A66	6 x 6	24 x 24	1 Way	●		
SMD3P2S66	6 x 6	24 x 24	2 Way	●		
SMD3P2G66	6 x 6	24 x 24	2 Way Corner	●		
SMD3P3A66	6 x 6	24 x 24	3 Way	●		
SMD3P4A66	6 x 6	24 x 24	4 Way	●		
SMD3P1S99	9 x 9	24 x 24	1 Way	●		
SMD3P2S99	9 x 9	24 x 24	2 Way	●		
SMD3P2G99	9 x 9	24 x 24	2 Way Corner	●		
SMD3P3A99	9 x 9	24 x 24	3 Way	●		
SMD3P4A99	9 x 9	24 x 24	4 Way	●		
SMD3P1S1212	12 x 12	24 x 24	1 Way	●		
SMD3P2S1212	12 x 12	24 x 24	2 Way	●		
SMD3P2G1212	12 x 12	24 x 24	2 Way Corner	●		
SMD3P3A1212	12 x 12	24 x 24	3 Way	●		
SMD3P4A1212	12 x 12	24 x 24	4 Way	●		
SMD3P4A1515	15 x 15	24 x 24	4 Way	●		
SMD3P4A1818	18 x 18	24 x 24	4 Way	●		

## Square/Round Ceiling Diffusers

---

### Model SCVD-Curved Vane Diffuser

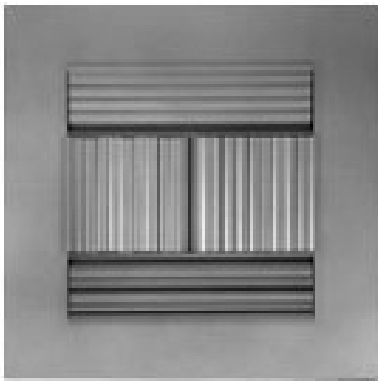

- *Construction: Formed Steel Construction*
- *Finish: White*
- *Damper: VCS3 Opposed blade damper*
- *Curved vanes are individually adjustable from the grille face.*

ACP Part Number	Inlet Size	Frame	Cle	Col	Tol
SCVD366	6 x 6	Surface	●		
SCVD388	8 x 8	Surface	●		
SCVD31010	10 x 10	Surface	●		
SCVD31212	12 x 12	Surface	●		
SCVD31414	14 x 14	Surface	●		

### Model RCDE-Round Cone Diffuser



- *Construction: Steel*
- *Finish: White*
- *Two horizontal discharge settings for different flow rate conditions.*
- *Deeply contoured outer cone prevents smudging.*

ACP Part Number	Inlet Size	Cle	Col	Tol
RCDE6	6"	●	●	
RCDE8	8"	●	●	
RCDE10	10"	●	●	
RCDE12	12"	●	●	

## Auer Registers

---

### Model #16

▀ *Round Ceiling Diffusers*



ACP Part Number	Size	Cle	Col	Tol
1606	6"	●		
1608	8"	●		

### Model #12B

▀ *Round Damper w/Ring*



ACP Part Number	Size	Cle	Col	Tol
12B06D	6"	●		
12B08D	8"	●		

### Model #3800

▀ *Damper without Ring*

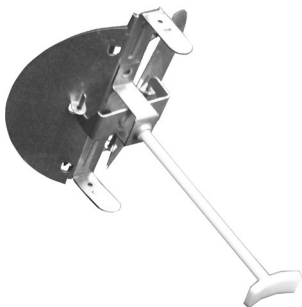

ACP Part Number	Size	Cle	Col	Tol
3806	6"	●		
3808	8"	●		
3810	10"	●		
3812	12"	●		
*Discontinued Item, Contact for availability				

## Perforated Diffusers

### Model PDF/3 Perforated Supply Diffuser



- *Construction: Steel construction*
- *Finish: White*
- *Louvered air pattern controllers are located on the diffuser face and are field adjustable to the desired air pattern.*
- *Hinged, removable perforated faceplate with quick release spring latches.*

ACP Part Number	Inlet Size	Frame	Face Size	Air Pattern	Cle	Col	Tol
PDF36	6"	Type 3 Lay-In	24 x 24	4-Way	●	●	
PDF38	8"	Type 3 Lay-In	24 x 24	4-Way	●	●	
PDF310	10"	Type 3 Lay-In	24 x 24	4-Way	●	●	
PDF312	12"	Type 3 Lay-In	24 x 24	4-Way	●	●	
PDF314	14"	Type 3 Lay-In	24 x 24	4-Way	●	●	

### Model PDC Perforated Supply Diffuser

#### **Individually Adjustable Curved Blades**



- *Construction: Steel construction*
- *Finish: White*
- *Individually pivoting curved blades are located at the inlet neck and are field adjustable from horizontal to vertical air pattern.*
- *Hinged, removable perforated faceplate with quick release spring latches.*

ACP Part Number	Inlet Size	Frame	Face Size	Air Pattern	Cle	Col	Tol
PDC36	6"	Type 3 Lay-In	24 x 24	4-Way	●		
PDC38	8"	Type 3 Lay-In	24 x 24	4-Way	●		
PDC310	10"	Type 3 Lay-In	24 x 24	4-Way	●		
PDC312	12"	Type 3 Lay-In	24 x 24	4-Way	●		
PDC314	14"	Type 3 Lay-In	24 x 24	4-Way	●		



## Perforated Diffusers

### Model PDDR/3 Perforated Return Diffuser



- *Construction: Steel construction with an aluminum face*
- *Finish: White*
- *Hinged, removable perforated faceplate with quick release spring latches.*

ACP Part Number	Inlet Size	Frame	Face Size	Cle	Col	Tol
PDDR36	6"	Type 3 Lay-In	24 x 24	●	●	
PDDR38	8"	Type 3 Lay-In	24 x 24	●	●	
PDDR310	10"	Type 3 Lay-In	24 x 24	●	●	
PDDR312	12"	Type 3 Lay-In	24 x 24	●	●	
PDDR314	14"	Type 3 Lay-In	24 x 24	●	●	
PDDR32210	22 x 10	Type 3 Lay-In	24 x 12	●	●	
PDDR32222	22 x 22	Type 3 Lay-In	24 x 24	●	●	

### Model PDMC/3 Modular Core Diffuser

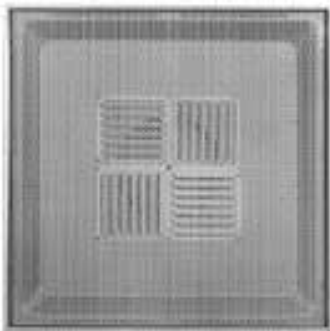

- *Construction: Steel construction*
- *Finish: White*
- *Perforated face panel has 3/16" diameter holes staggered 1/4" on center.*
- *Four louvered air pattern modules are located at the neck and can be easily repositioned in the field without tools.*

ACP Part Number	Inlet Size	Frame	Face Size	Air Pattern	Cle	Col	Tol
PDMC388	8 x 8	Type 3 Lay-In	24 x 24	4-Way	●		
PDMC31212	12 x 12	Type 3 Lay-In	24 x 24	4-Way	●		
PDMC31818	18 x 18	Type 3 Lay-In	24 x 24	4-Way	●		

## Grilles & Registers

### Model 520D-Double Deflection Louvered Supply Register with Damper

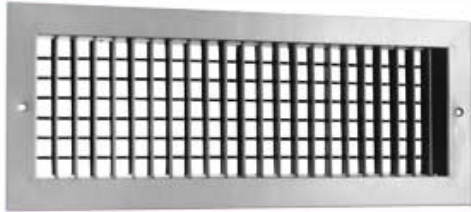

- *Construction: Steel*
- *Finish: White*
- *Blade Spacing: 3/4"*
- *Mounting: Surface Frame*
- *Countersunk screw holes with oval head screws*
- *CFM is based on @<NC30 please see Price Industries catalog for further details.*

ACP Part Number	Size	Cle	Col	Tol	@<NC30
520D66	6 x 6	●	●		180
520D84	8 x 4	●	●		180
520D86	8 x 6	●	●		220
520D88	8 x 8	●	●		390
520D104	10 x 4	●	●		220
520D106	10 x 6	●	●		340
520D108	10 x 8	●	●		370
520D1010	10 x 10	●	●		480
520D124	12 x 4	●	●		260
520D126	12 x 6	●	●	●	390
520D128	12 x 8	●	●		480
520D1210	12 x 10	●	●		550
520D1212	12 x 12	●	●		720
520D144	14 x 4	●	●		300
520D146	14 x 6	●	●		370
520D148	14 x 8	●	●	●	550
520D1410	14 x 10	●	●		650
520D1412	14 x 12	●	●		855
520D1414	14 x 14	●	●		945
520D164	16 x 4	●	●		340
520D166	16 x 6	●	●		415
520D168	16 x 8	●	●	●	650
520D1610	16 x 10	●	●		720
520D1612	16 x 12	●	●		945
520D184	18 x 4	●	●		390

ACP Part Number	Size	Cle	Col	Tol	@<NC30
520D186	18 x 6	●	●		480
520D188	18 x 8	●	●		720
520D1810	18 x 10	●	●		855
520D1812	18 x 12	●	●	●	1070
520D204	20 x 4	●	●		370
520D206	20 x 6	●	●		550
520D208	20 x 8	●	●		650
520D2010	20 x 10	●	●		945
520D2012	20 x 12	●	●		1070
520D244	24 x 4	●	●		525
520D246	24 x 6	●	●		590
520D248	24 x 8	●	●		720
520D2410	24 x 10	●	●		1280
520D2412	24 x 12	●	●	●	1440
520D2414	24 x 14	●	●		1660
520D2418	24 x 18	●	●		1950
520D304	30 x 4	●	●		550
520D306	30 x 6	●	●		790
520D308	30 x 8	●	●		945
520D3010	30 x 10	●	●		1460
520D3012	30 x 12	●	●		1640
520D364	36 x 4	●	●		650
520D366	36 x 6	●	●		810
520D368	36 x 8	●	●		1070
520D3610	36 x 10	●	●		1720
520D3612	36 x 12	●	●		1950

## Grilles & Registers

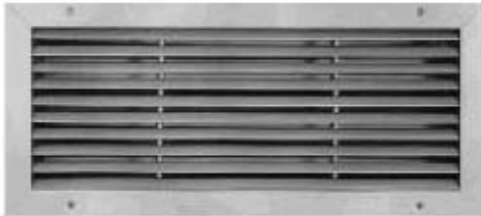

### Model 530-Louvered Return Grille

- *Construction: Steel*
- *Finish: White*
- *Blade Spacing: 3/4" - fixed louvers - 45 degree deflection*
- *Countersunk screw holes with oval head screws on surface mounted grilles.*

ACP Part Number	Size	Frame	Cle	Col	Tol	ACP Part Number	Size	Frame	Cle	Col	Tol
53066	6 x 6	Surface	●	●	●	530208	20 x 8	Surface	●	●	
53084	8 x 4	Surface	●	●		5302010	20 x 10	Surface	●	●	
53086	8 x 6	Surface	●	●		5302012	20 x 12	Surface	●	●	
53088	8 x 8	Surface	●	●	●	5302018	20 x 18	Surface	●	●	
530106	10 x 6	Surface	●	●		5302020	20 x 20	Surface	●	●	
530108	10 x 8	Surface	●	●		530224LI	22 X 4	Lay In			●
5301010	10 x 10	Surface	●	●	●	530226LI	22 x 6	Lay In	●		●
5301010LI	10 x 10	Lay-in -NSH	●		●	5302210LI	22 x 10	Lay In	●		●
530126	12 x 6	Surface	●	●		5302222LI	22 x 22	Lay In	●		●
530128	12 x 8	Surface	●	●		530248	24 x 8	Surface	●	●	
5301210	12 x 10	Surface	●	●		5302410	24 x 10	Surface	●	●	
5301212	12 x 12	Surface	●	●	●	5302414	24 x 12	Surface	●	●	
530146	14 x 6	Surface	●	●		5302414	24 x 14	Surface	●	●	
530148	14 x 8	Surface	●	●		5302416	24 x 16	Surface	●	●	
5301410	14 x 10	Surface	●	●		5302418	24 x 18	Surface	●	●	
5301412	14 x 12	Surface	●	●		5302420	24 x 20	Surface	●	●	
5301414	14 x 14	Surface	●	●		5302424	24 x 24	Surface	●	●	
530166	16 x 6	Surface	●	●		530308	30 x 8	Surface	●	●	
530168	16 x 8	Surface	●	●		5303010	30 x 10	Surface	●	●	
5301610	16 x 10	Surface	●	●		5303012	30 x 12	Surface	●	●	
5301612	16 x 12	Surface	●	●		5303018	30 x 18	Surface	●	●	
5301614	16 x 14	Surface	●	●		5303020	30 x 20	Surface	●	●	
5301616	16 x 16	Surface	●	●		5303024	30 x 24	Surface	●	●	
530186	18 x 6	Surface	●	●		5303030	30 x 30	Surface	●	●	
530188	18 x 8	Surface	●	●		5303610	36 x 10	Surface	●	●	
5301810	18 x 10	Surface	●	●		5303612	36 x 12	Surface	●	●	
5301812	18 x 12	Surface	●	●		5303614	36 x 14	Surface	●	●	
5301814	18 x 14	Surface	●	●		5303618	36 x 18	Surface	●	●	
5301816	18 x 16	Surface	●	●		5303620	36 x 20	Surface	●	●	
5301818	18 x 18	Surface	●	●		5303624	36 x 24	Surface	●	●	
530206	20 x 6	Surface	●	●		5303630	36 x 30	Surface	●	●	
						5304622LI	46 x 22	Lay In	●	●	●

## Grilles & Registers

---



### **Model 530FF-Louvered Face Filter Return Grille**

- *Construction: Steel*
- *Finish: White*
- *Blade Spacing: 3/4" - 45 degree deflection*
- *Accepts 1" - 20 x 20 filter*
- *Hinged tab mechanism with 1/4 turn quick-release fasteners.*

ACP Part Number	Size	Frame	Cle	Col	Tol
5302424FF	24 x 24	Lay-In	●	●	

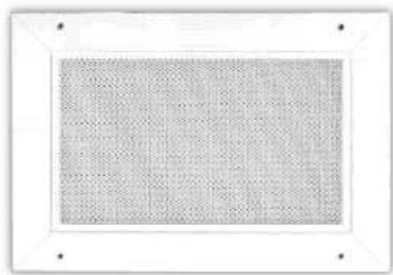

### **Model 10-Perforated Face Return Grille**

- *Construction: Steel core with extruded aluminum borders*
- *Finish: White*
- *Core free area of approximately 50%.*

ACP Part Number	Inlet Size	Frame	Cle	Col	Tol
102210	22 x 10	Lay-In	●		
1066	6 x 6	Surface	●		
1088	8 x 8	Surface	●		
101010	10 x 10	Surface	●		
101212	12 x 12	Surface	●		

## Model: RGS-3 Register for Spiral Duct

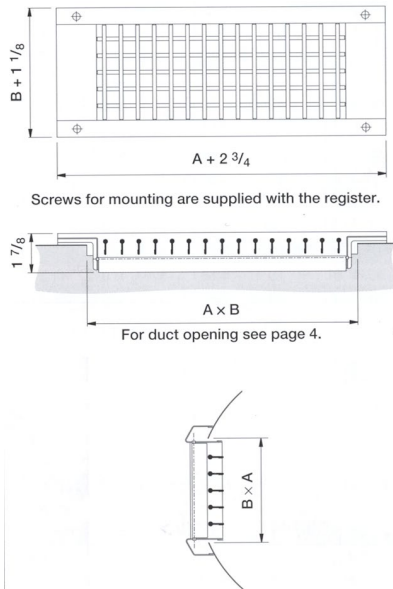

➤ *RGS is a supply/return register with adjustable double deflection blades and a volume damper designed specifically for direct mounting on a spiral duct. The use of rectangular register taps are not required.*

➤ *The register is designed in such a way that the flanges always meet flush to the duct regardless of the duct diameter. It also comes equipped with end caps and a gasketing material installed around the neck of the register to prevent air leakage.*

➤ *RGS is manufactured from galvanized sheet metal and is assembled without the use of welding. This allows the register to be used without further surface treatment and gives it the same finish as the duct.*

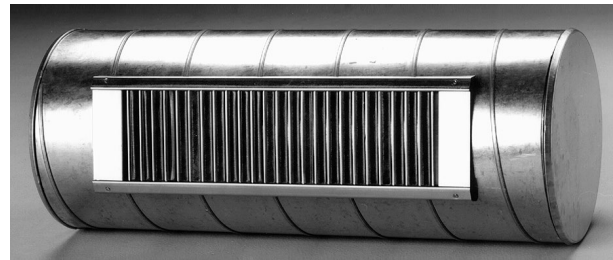

ACP Part Number	Size	Min. duct Diameter (in)	Free Area (ft <sup>2</sup> )	Duct Opening A X B (in)	Weight (lbs.)	Cle	Col	Tol
RGS133	13 x 3	6	0.18	12 3/4 x 3	2.4	●	●	
RGS173	17 x 3	6	0.25	16 3/4 x 3	3.1	●	●	●
RGS136	13 x 6	12	0.36	12 3/4 x 6	3.1	●	●	●
RGS176	17 x 6	12	0.48	16 3/4 x 6	4.2	●	●	●
RGS216	21 x 6	12	0.60	20 5/8 x 6	5.1	●	●	●
RGS256	25 x 6	12	0.73	24 5/8 x 6	5.7	●	●	
RGS336	33 x 6	12	1	32 1/2 x 6	7.7	●	●	●

## Price RAC Return Air Canopy

*The return air canopy provides a low cost solution for improving speech privacy between adjoining spaces. This laboratory tested product provides noise attenuation while allowing for maximum airflow through the return grille.*

- *Fits standard return grille sizes*
- *Speech privacy between offices*
- *Reduces visibility into plenum*
- *Installs easily within T-Bar ceiling*

ACP Part Number	Size	Cle	Col	Tol
RAC1224	12 x 24	●		
RAC2424	24 x 24	●		



# Grilles & Accessories

## Model 80-Eggcrate Face Return Grille

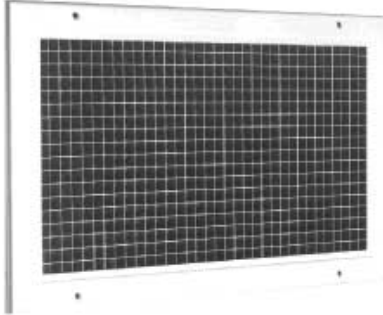

- *Construction: ½" x ½" x ½" aluminum grid core, extruded aluminum frames*
- *Finish: White*
- *Countersunk screw holes with oval head screws.*

ACP Part Number	Inlet Size	Frame	Cle	Col	Tol
8066	6 x 6	Surface	●	●	●
8088	8 x 8	Surface	●	●	●
801010	10 x 10	Surface	●	●	●
801010LI	10 x 10	Lay In	●	●	●
801212	12 x 12	Surface	●	●	●
801414	14 x 14	Surface		●	
80224LI	22 x 4	Lay In		●	●
80226LI	22 x 6	Lay In	●	●	●
802210LI	22 x 10	Lay In	●		●
802222LI	22 x 22	Lay In	●		●
802424	24 x 24	Surface			
802424FF	24 x 24	Lay in		●	
804622LI	46 x 22	Lay In	●		

### Model VCR9 Radial Shutter Damper

ACP Part Number	Size	Cle	Col	Tol
VCR96	6"	●	●	●
VCR98	8"	●	●	●
VCR910	10"	●	●	●
VCR912	12"	●	●	●
VCR914	14"	●	●	

### Model PFRF -Perforated Return Panel

ACP Part Number	Size	Cle	Col	Tol
PFRF2412	24 x 12	●		
PFRF2424	24 x 24	●		

### Surface Mount Adaptor Frame

ACP Part Number	Size	Cle	Col	Tol
AMF1212MC	12 x 12	●	●	
AMF2412MC	24 x 12	●	●	
AMF2424MC	24 x 24	●	●	
SPF1212	12 x 12			●
SPF2424	24 x 24			●

### Model VCS3 Opposed Blade Damper

ACP Part Number	Size	Cle	Col	Tol
VCS366	6 x 6	●	●	
VCS388	8 x 8	●	●	
VCS399	9 x 9	●		
VCS31010	10 x 10	●	●	
VCS31212	12 x 12	●	●	
VCS31414	14 x 14	●	●	
VCS31515	15 x 15	●		
VCS31818	18 x 18	●	●	
VCS32210	22 x 10	●	●	
VCS32222	22 x 22	●	●	
VCS32412	24 x 12	●	●	

### Round Equalizing Grids

ACP Part Number	Inlet Size	Cle	Col	Tol
EGR6	6"	●	●	
EGR8	8"	●	●	
EGR10	10"	●	●	
EGR12	12"	●	●	
EGR14	14"	●	●	



## VAV Boxes

### Model SDV Single Duct Terminal Unit - Bare Box

- Hospital Grade **FIBER FREE LINING**
- 22 Ga. zinc coated steel housing, mechanically sealed and gasketed, leak resistant construction.
- Rectangular discharge opening with slip and drive cleat duct connection.
- Control Enclosure
- 115-24 Volt transformers
- Actuator & controls by others

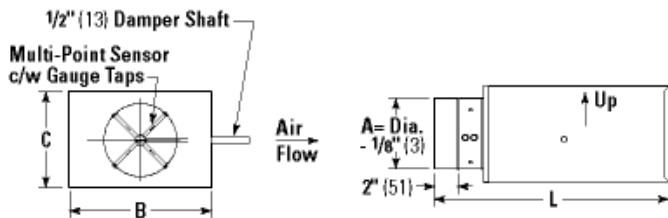

ACP Part Number	Inlet Size (A)	Cle	Col	Tol
SDV56	6"	●		●
SDV58	8"	●		●
SDV510	10"	●		●
SDV512	12"	●		●
SDV514	14"	●		●
SDV516	16"	●		
SDV52416	24 x 16	●		

### Model SPV Single Duct Terminal Unit with Pneumatic Controls

- Hospital Grade **FIBER FREE LINING**
- 22 Ga. zinc coated steel housing, mechanically sealed and gasketed, leak resistant construction.
- Rectangular discharge opening with slip and drive cleat duct connection.
- Control assembly will be supplied as illustrated on right hand side.
- Gauge taps are standard.
- Pneumatic actuator supplied & mounted by Price.

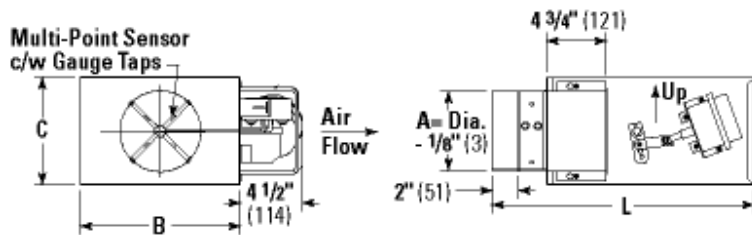

ACP Part Number	Inlet Size (A)	Cle	Col	Tol
SPV86	6"	●		
SPV88	8"	●		
SPV810	10"	●		
SPV812	12"	●		
SPV814	14"	●		
SPV816	16"	●		
SPV82416	24 x 16	●		

### DIMENSIONAL DATA

Unit Size	CFM Range	Imperial Units (inches)			
		Outlet		Inlet	Length
B	C	A	L		
6"	0-450	12	8	6	20 1/8
8"	0-800	12	10	8	20 1/8
10"	0-1350	14	12 1/2	10	20 1/8
12"	0-2100	16	15	12	20 1/8
14"	0-3000	20	17 1/2	14	23 5/8
16"	0-4000	24	18	16	23 5/8





## VAV Accessories

### 2 Row Hot Water Coil

- Fabricated from 22 ga. galvanized steel, mechanically sealed
- Leak resistant construction
- Standard coils supplied with 10 fins per inch.
- Performance rated and certified in accordance with the current edition of ARI standard 410.

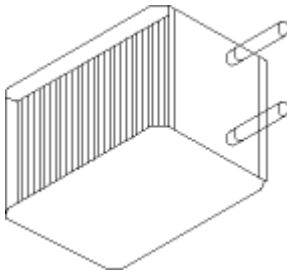

ACP Part Number	VAV Box Size	Imperial Units (Inches)		Cle	Col	Tol
		B	C			
2RCOIL6	6"	12	8	●		●
2RCOIL8	8"	12	10	●		●
2RCOIL10	10"	14	12 1/2	●		●
2RCOIL12	12"	16	15	●		●
2RCOIL14	14"	20	17 1/2	●		●
2RCOIL16	16"	24	18	●		
2RCOIL2416	24 X16	38	18	●		

### Model CP101 Pneumatic Controller

*Provides maximum versatility. Accommodates direct and reverse acting thermostats, and either normally open or normally closed damper positions. Reset start point and span are adjustable. Maintains a constant reset span regardless of minimum and maximum settings.*



ACP Part Number	Model	Cle	Col	Tol
CP101	CP101	●		

### Actuator

- Metal body to meet local codes for ceiling plenum applications.
- Actuator body can be rotated 360 degrees for positioning air connection.
- Slotted shaft allows direct connection to VAV damper linkage.
- For use in proportional or two position application.

ACP Part Number	Model	Cle	Col	Tol
MCP8031	MCP 8031-3102	●		

## Motor Operated Round Dampers

### Model RDV – Round VVT, VAV and Shut Off Damper

- *Retrofit/Round/VAV*
- *General exhaust of non-corrosive room air*
- *Removable flow sensor*
- *Duct and damper constructed of 22 ga zinc-coated steel, mechanically fastened.*
- *Stocked without controls or actuators*

ACP Part Number	Inlet Size	Cle	Col	Tol
RDV56	6"	●		
RDV58	8"	●		
RDV510	10"	●		
RDV512	12"	●		
RDV514	14"	●		



### Spring Return Round Dampers

- *24 Volt Actuator*
- *110 Volt Actuator*
- *14" & 16" Dampers only available with 24 Volt Hi Torque Motor*
- *3 Year Factory Warranty*

ACP Part Number	Inlet Size	Cle	Col	Tol
SPRD1106	6"Ø damper with 110V Motor	●		
SPRD1108	8"Ø damper with 110V Motor	●		
SPRD11010	10"Ø damper with 110V Motor	●		
SPRD11012	12"Ø damper with 110V Motor	●		
NSPRD0246	6"Ø damper with 24V Motor	●		
NSPRD0248	8"Ø damper with 24V Motor	●		
NSPRD02410	10"Ø damper with 24V Motor	●		
NSPRD02412	12"Ø damper with 24V Motor	●		
SRHT02414	14"Ø damper with 24V Hi-Torque Motor	●		
SRHT02416	16"Ø damper with 24V Hi-Torque Motor	●		

## Price/Donco Slot Diffusers

### DCD Series-2 Slot Diffuser

- 24 Gauge galvanized steel – Tee Bars are white
- All exposed surfaces painted flat black
- Aluminum vanes with felt seals are fully adjustable from the face for left, right, or vertical throw.
- Designed for variable or constant volume systems, heating or cooling.



ACP Part Number	Neck Size	Length/Slot	Slot Width	Cle	Col	Tol
DCD246	6"	24" 2 Slot	1"	●		
DCD486	6"	48" 2 Slot	1"	●		
DCD488	8"	48" 2 Slot	1"	●		
DCD4810	10"	48" 2 Slot	1"	●		

### Surface Mount Frame

- For use with the DCD Series 48" long diffusers.

ACP Part Number	Length/Slot	Description	Cle	Col	Tol
TBF48	48" 2 Slot	TB Surface Mount Frame	●		

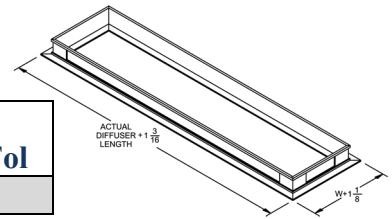

### J Series- Slot Diffuser

- 24 gauge galvanized steel – All exposed surfaces have white enamel finish.
- Fixed vane provides a draftless air pattern over the pattern over the full range of flow.
- Lower flanges provide tile support as an integral part of the diffuser housing.

ACP Part Number	Neck Size	Length / Slot	Slots Width	Cle	Col	Tol
J22246	6"	24" 2 Slot	1"	●		
J22248	8"	24" 2 Slot	1"	●		
J222410	10"	24" 2 Slot	1"	●		

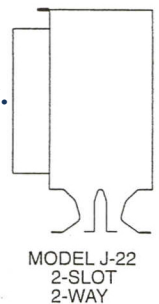

### SDS Series- Linear Slot Diffuser

- Type 2 Surface Mounted
- 1" Slot
- 180° air pattern adjustable and complete flow rate control with stable horizontal air pattern.

ACP Part Number	Neck Size	Length / Slot	Slots Width	Cle	Col	Tol
SDS100	48"	48" 2 Slot	1"	●		
Plenum-UPL	8" oval	48" 2 Slot	1"	●		

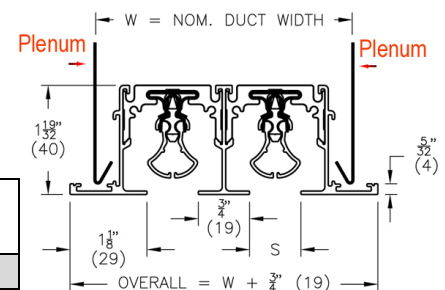

## Varitherm Thermally Powered VAV Diffusers

### Features

- ▶ *Individual VAV zone control*
- ▶ *Individual heating and cooling set points*
- ▶ *Balancing/force open mode*
- ▶ *Easy installation and balancing*
- ▶ *Easy adjustable minimum airflow*
- ▶ *Saves energy on existing & new systems*
- ▶ *Room side access of all control adjustments*
- ▶ *Low-pressure drop and quiet operation*
- ▶ *ARI certified data*
- ▶ *10 Year Warranty*

The Varitherm uses built in thermal actuators that monitor supply and room air temperature and adjust an integral damper to vary the flow of conditioned air to the space.

**Cost Effect:** The Varitherm provides energy savings and increased thermal comfort through the creation of smaller zones

**Retrofi:** The Varitherm is also available as retrofit to Prices popular SPD (square plaque diffuser) or SCD (square cone diffuser) to help with trouble zones .

### Optimal Control

The Varitherm VPD-HC senses when heating or cooling is required, and automatically adjusts itself to maintain control. To provide greater comfort year-round, the temperature set points for heating and cooling modes can be adjusted individually. With these features the diffuser responds to changes in heating/cooling demand with smooth and accurate transitions.

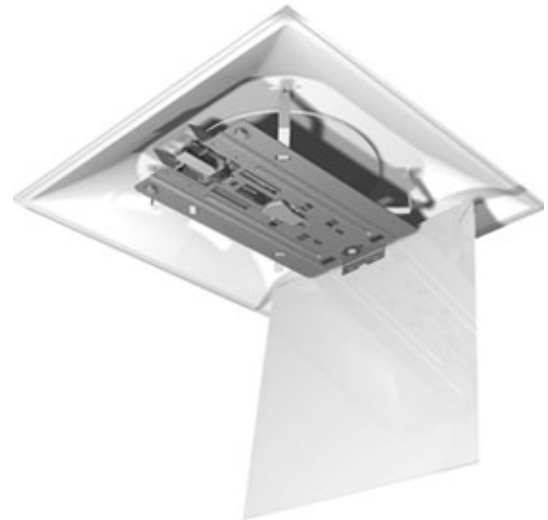

ACP Part Number	Model	Size	Description	Cle	Col	Tol
VPD24246	VPD-HC*	6"	24 x 24 Lay-In	●		
VPD24248	VPD-HC*	8"	24 x 24 Lay-In	●		
VPD242410	VPD-HC*	10"	24 x 24 Lay-In	●		
VPD242412	VPD-HC*	12"	24 x 24 Lay-In	●		
PRC6	PRC	6"	Pressure Relief Collar	●		
PRC8	PRC	8"	Pressure Relief Collar	●		
PRC10	PRC	10"	Pressure Relief Collar	●		
PRC12	PRC	12"	Pressure Relief Collar	●		

\*HC = Heating/Cooling

## SPIROSafe® SPIRAL PIPE

### Features

- ▶ *Less money - Better performance*
- ▶ *Double lipped, double-sealing gasket patented sealing system*
- ▶ *Slip components together & secure with sheet metal screws.*
- ▶ *No caulking - No taping*
- ▶ *Installs up to 30% faster than traditional ductwork*
- ▶ *Fully functional from -20°F to +212° F*
- ▶ *Paint Grip not required for field painting.*



Air Control Products, Inc. Cleveland Warehouse

ACP Part Number	Size	Cle	Col	Tol
SR3	3"	●	●	
SR4	4"	●	●	●
SR5	5"	●	●	●
SR6	6"	●	●	●
SR7	7"	●	●	●
SR8	8"	●	●	●
SR9	9"	●		●
SR10	10"	●	●	●
SR12	12"	●	●	●
SR14	14"	●	●	●
SR16	16"	●	●	●
SR18	18"	●	●	●
SR20	20"	●	●	●
SR22	22"	●	●	●
SR24	24"	●	●	●
SR26	26"	●		●
SR28	28"	●		●
SR30	30"	●		●
SR32	32"	●		
SR34	34"	●		
SR36	36"	●		

Sold in 10' length sections

### TOLERANCES FOR SPIRAL PIPES

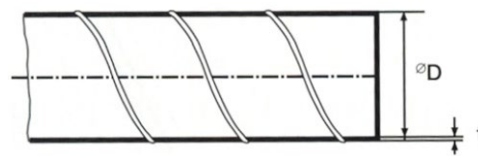

$\varnothing d$ (in)	$\varnothing d$ Tol (in) min - max	$t$ ga†	$\varnothing d$ (in)	$\varnothing d$ Tol (in) min - max	$t$ ga†
3*	2.950-2.969	28	14*	13.950-13.976	28
4*	3.950-3.969	28	16*	15.936-15.969	26
5*	4.950-4.969	28	18*	17.936-17.969	26
6*	5.950-5.969	28	20*	19.936-19.972	26
7*	6.950-6.972	28	22*	21.936-21.972	26
8*	7.950-7.972	28	24*	23.936-23.976	26
9*	8.950-8.972	28	26*	25.936-25.976	24
10*	9.950-9.976	28	28*	27.934-27.976	24
12*	11.950-11.976	28	30*	29.924-29.969	24

\*Standard Diameters \*Per latest SMACNA Standards

## 90° Elbows

### Model BSU 90° Elbow

- ▶ Die stamped
- ▶ Continuously stitch welded
- ▶ Rolled edges
- ▶  $r_c \approx 1.5 \times d_1$

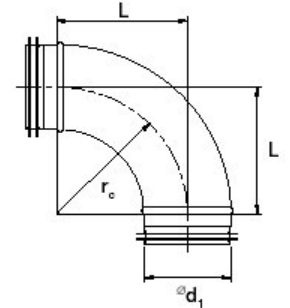

ACP Part Number	$\varnothing d_1$ (in)	L (in)	Weight (lbs.)	Cle	Col	Tol
BSU903	3"	4 1/2	1.0	●		
BSU904	4"	6	1.4	●	●	●
BSU905	5"	7 1/2	1.8	●		●
BSU906	6"	9	2.8	●	●	●
BSU907	7"	10 1/2	3.5	●		●
BSU908	8"	12	5.0	●	●	●
BSU909	9"	13 1/2	8.2	●		●
BSU9010	10"	15	10.3	●	●	●
BSU9012	12"	18	13.8	●	●	●

### Model BSFU 90° Elbow

- ▶ 5 gore standing seam
- ▶ Gore locked and internally sealed
- ▶  $r_c \approx 1.5 \times d_1$

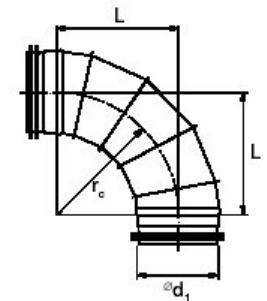

ACP Part Number	$\varnothing d_1$ (in)	L (in)	Weight (lbs.)	Cle	Col	Tol
BSFU9014	14"	21	16.1	●	●	●
BSFU9016	16"	24	21.8	●	●	●
BSFU9018	18"	27	26.9	●	●	●
BSFU9020	20"	30	32.6	●	●	●
BSFU9022	22"	33	43.7	●	●	●
BSFU9024	24"	36	51.4	●	●	●
BSFU9026	26"	39	63.2	●		
BSFU9028	28"	42	72.6	●		
BSFU9030	30"	45	83.5	●		



## 45° Elbows

### Model BSU 45° Elbow

- ▶ Die stamped
- ▶ Continuously stitch welded
- ▶ Rolled edges
- ▶  $r_c \approx 1.5 \times d_1$

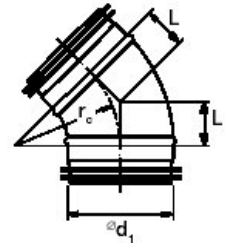

ACP Part Number	ød <sub>1</sub> (in)	L (in)	Weight (lbs.)	Cle	Col	Tol
BSU453	3"	1 3/4	0.4	●		
BSU454	4"	2 1/2	0.7	●	●	●
BSU455	5"	3 1/8	0.9	●		●
BSU456	6"	3 3/4	1.4	●	●	●
BSU457	7"	4 3/8	1.7	●		●
BSU458	8"	5	2.5	●	●	●
BSU459	9"	5 1/8	4.1	●		●
BSU4510	10"	5 3/4	5.1	●	●	●
BSU4512	12"	7	6.9	●	●	●

### Model BSFU 45° Elbow

- ▶ 3 gore standing seam
- ▶ Gore locked and internally sealed
- ▶  $r_c \approx 1.5 \times d_1$

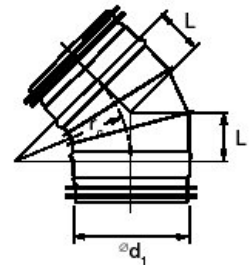

ACP Part Number	ød <sub>1</sub> (in)	L (in)	Weight (lbs.)	Cle	Col	Tol
BSFU4514	14"	8 3/4	8.1	●	●	●
BSFU4516	16"	10	10.9	●	●	●
BSFU4518	18"	11 1/8	13.5	●	●	●
BSFU4520	20"	12 3/8	16.3	●	●	●
BSFU4522	22"	13 5/8	21.9	●	●	●
BSFU4524	24"	14 7/8	25.7	●	●	●
BSFU4526	26"	16 1/8	31.6	●		●
BSFU4528	28"	17 3/8	36.3	●		●
BSFU4530	30"	18 5/8	41.8	●		



## Couplings/Connectors

### Model NPU Coupling - Used for joining spiral duct

ACP Part Number	Ød <sub>1</sub> (in)	L (in)	Weight (lbs.)	Cle	Col	Tol
NPU3	3"	3/8	0.2	●		
NPU4	4"	3/8	0.2	●	●	●
NPU5	5"	3/8	0.4	●		●
NPU6	6"	3/8	0.4	●	●	●
NPU7	7"	3/8	0.7	●		●
NPU8	8"	3/8	0.7	●	●	●
NPU9	9"	3/8	0.9	●		●
NPU10	10"	3/8	1.1	●	●	●
NPU12	12"	3/8	1.3	●	●	●
NPU14	14"	3/8	1.5	●	●	●
NPU16	16"	3/8	2.9	●	●	●
NPU18	18"	3/8	3.2	●	●	●
NPU20	20"	3/8	3.6	●	●	●
NPU22	22"	1/2	4.0	●	●	●
NPU24	24"	1/2	4.2	●	●	●
NPU26	26"	1/2	4.5	●		●
NPU28	28"	5/8	6.0	●		●
NPU30	30"	5/8	7.5	●		●

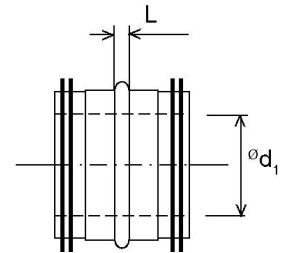

### Model MF Connector - Used for joining fittings

ACP Part Number	ØD (in)	L (in)	Weight (lbs.)	Cle	Col	Tol
MF3	3"	3 5/8	0.2	●		
MF4	4"	3 5/8	0.2	●	●	●
MF5	5"	3 5/8	0.4	●		
MF6	6"	3 5/8	0.4	●	●	●
MF7	7"	3 5/8	0.7	●		
MF8	8"	3 5/8	0.7	●	●	●
MF9	9"	3 5/8	0.7	●		
MF10	10"	5 1/8	1.1	●	●	●
MF12	12"	5 1/8	1.3	●	●	●
MF14	14"	5 1/8	1.5	●	●	●
MF16	16"	6 5/8	2.9	●	●	●
MF18	18"	6 5/8	3.2	●	●	●
MF20	20"	6 5/8	3.6	●	●	●
MF22	22"	6 5/8	4.0	●	●	●
MF24	24"	6 5/8	4.3	●	●	●
MF26	26"	6 3/4	5.0	●		
MF28	28"	8 5/8	6.0	●		
MF30	30"	8 5/8	7.5	●		



## End Caps & Tees

### Model ESU End Cap

► *End cap for spiral duct*

ACP Part Number		∅d <sub>1</sub> (in)	L (in)	Weight (lbs.)	Cle	Col	Tol
ESU3	*	3"	3/8	0.2	●		
ESU4		4"	3/8	0.2	●	●	●
ESU6		6"	3/8	0.2	●	●	●
ESU8		8"	3/8	0.7	●	●	●
ESU10		10"	3/8	1.3	●	●	●
ESU12		12"	3/8	1.7	●	●	●
ESU14	*	14"	3/8	2.6	●	●	●
ESU16	*	16"	3/8	2.8	●	●	●
ESU18	*	18"	3/8	3.9	●	●	●
ESU20	*	20"	3/8	3.9	●		●
ESU22	*	22"	1/2	4.8	●	●	●
ESU24	*	24"	1/2	5.9	●		●

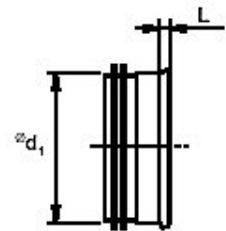

\*Fabricated. Others die-stamped

### Model TCPU Tee

- *90° Straight tee*
- *Assembled tee with die-stamped or fabricated PSU*

ACP Part Number	∅d <sub>1</sub> (in)	∅d <sub>3</sub> (in)	L (in)	H (in)	Weight (lbs.)	Cle	Col	Tol
TCPU444	4"	4"	6"	2 5/8	1.1	●	●	●
TCPU666	6"	6"	9"	4 1/8	2.1	●	●	●
TCPU888	8"	8"	11"	5	3.2	●	●	●
TCPU101010	10"	10"	13 3/4"	6	5.0	●	●	●
TCPU121212	12"	12"	15 3/8"	7 1/8	6.6	●	●	●

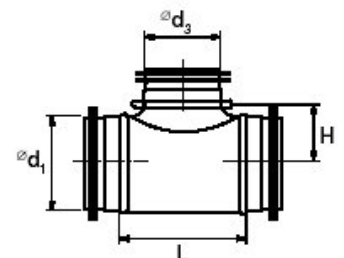

# Reducers

## Model RCU Reducer

► *Die stamped concentric reducers*

ACP Part Number		Ød <sub>1</sub> (in)	Ød <sub>2</sub> (in)	L (in)	Weight (lbs.)	Cle	Col	Tol
RCU43	*	4"	3"	3/4	0.2	●		
RCU54		5"	4"	7/8	0.2	●		
RCU64		6"	4"	1 1/4	0.6	●	●	●
RCU65		6"	5"	3/4	0.4	●		
RCU76		7"	6"	1	0.7	●		
RCU84		8"	4"	2 1/4	0.9	●	●	●
RCU85		8"	5"	1 5/8	0.9	●		
RCU86		8"	6"	1 1/4	0.7	●	●	●
RCU87		8"	7"	3/4	0.7	●		
RCU98		9"	8"	1 1/8	0.9	●		
RCU106		10"	6"	2 1/4	1.0	●	●	●
RCU108		10"	8"	1 1/8	1.4	●	●	●
RCU109		10"	9"	5/8	1.6	●		
RCU128		12"	8"	2 1/8	1.5	●	●	●
RCU1210		12"	10"	1 1/8	1.5	●	●	●
RCU148	*	14"	8"	3 3/8	2.6	●	●	●
RCU1410	*	14"	10"	2 3/8	2.4	●	●	●
RCU1412	*	14"	12"	1 3/8	2.2	●	●	●
RCU168		16"	8"	3 7/8	3.0	●	●	●
RCU1610		16"	10"	2 7/8	2.9	●	●	●
RCU1612	*	16"	12"	1 7/8	2.9	●	●	●
RCU1614	*	16"	14"	7/8	2.9	●	●	●

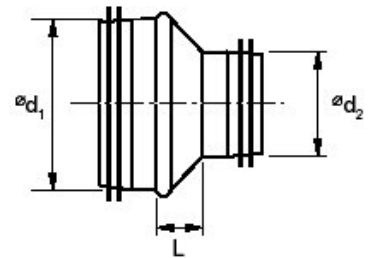

\*Fabricated- Others die-stamped

## Model RCLU Reducer

► *Fabricated concentric reducer*

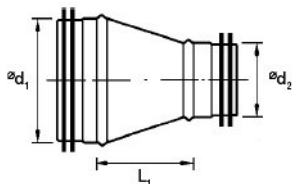

ACP Part Number	Ød <sub>1</sub> (in)	Ød <sub>2</sub> (in)	L (in)	Weight (lbs.)	Cle	Col	Tol
RCLU1812	18"	12"	8 7/8	5.1	●	●	●
RCLU1814	18"	14"	6 1/8	4.6	●	●	●
RCLU1816	18"	16"	3 5/8	4.3	●	●	●
RCLU2014	20"	14"	8 3/4	5.9	●	●	●
RCLU2016	20"	16"	6 1/4	5.5	●	●	●
RCLU2018	20"	18"	3 3/4	5.2	●	●	●
RCLU2216	22"	16"	10	7.4	●	●	●
RCLU2218	22"	18"	7 1/4	6.7	●	●	●
RCLU2220	22"	20"	4 3/8	5.8	●	●	●
RCLU2418	24"	18"	8 7/8	8.2	●	●	●
RCLU2420	24"	20"	6	6.7	●	●	●
RCLU2422	24"	22"	3 1/4	5.5	●	●	●
RCLU2624	26"	24"	3 7/8	7.0	●		●
RCLU2622	26"	22"	5	7.9	●		●
RCLU2826	28"	26"	4 3/8	8.3	●		●
RCLU3028	30"	28"	6 5/8	9.7	●		●

# Saddle Taps

## Model PSU

► Die stamped with radiused entry.

ACP Part Number	°D (in)	°d <sub>3</sub> (in)	r	H (in)	For Spiral Pipe °D (in)	Wt (lbs.)	Cle	Col	Tol
PSU43	4"	3"	1/2	2 3/8	4	0.2	●		
PSU44	4"	4"	5/8	2 5/8	4	0.5	●		●
PSU64	6"	4"	5/8	3 3/4	6	0.4	●	●	●
PSU66	6"	6"	7/8	4	6	0.7	●	●	●
PSU87-4	8/7"	4"	5/8	4 1/2	7-8	0.5	●	●	●
PSU87-6	8/7"	6"	7/8	4 7/8	7-8	0.7	●	●	●
PSU88-9	8"	8"	1	5	8	1.4	●	●	
PSU109-6	10/9"	6"	7/8	5 7/8	9-10	0.8	●	●	●
PSU109-8	10/9"	8"	1	6	9-10	1.2	●	●	●
PSU1010	10"	10"	1	6	10	2.1	●	●	●
PSU126	12"	6"	7/8	7	12	0.7	●	●	●
PSU128	12"	8"	1	7 1/8	12	1.1	●	●	●
PSU1210	12"	10"	1	7 1/8	12	1.5	●	●	●
PSU1212	12"	12"	1	7 1/8	12	2.7	●	●	●
PSU1814-6	18/14"	6"	7/8	8 7/8	14-18	0.6	●	●	●
PSU1614-8	16/14"	8"	1	8 7/8	14-16	1.2	●	●	●
PSU1410	14"	10"	1	8	14	1.5	●	●	●
PSU1412	14"	12"	1	8 1/2	14	2.0	●	●	●
PSU1414	*	14"	1	8 1/2	14	3.0	●	●	●
PSU1612	16"	12"	1	8 7/8	16	2.1	●	●	●
PSU1614	*	16"	1	8 7/8	16	3.1	●	●	●
PSU1616	16"	16"	1	8 7/8	16	4.4	●	●	●
PSU188	20/18"	8"	1	9 7/8	18-20	1.1	●	●	
PSU1814	*	18"	1	9 7/8	18	2.2	●	●	●
PSU1818	*	18"	5/8	9 1/2	18	0.5	●	●	
PSU2016-10	20/16"	10"	1	9 7/8	16-20	3.5	●	●	●
PSU2014	*	20"	0	9 7/8	20	2.4	●	●	●
PSU2016	20"	16"	1	11	18-20	3.5	●	●	●
PSU2018	*	20"	0	9 7/8	20	2.6	●	●	●
PSU2020	*	20"	0	9 7/8	20	2.9	●	●	
PSU2218-12	22/18"	12"	1	9 7/8	18-24	1.8	●	●	●
PSU2422-10	24/22"	10	1	13 3/4	22-24	1.1	●	●	
PSU2412	24"	12"	1	8 7/8	22-24	1.8	●	●	
PSU2414	*	24"	0	12	24	2.4	●	●	
PSU2422-16	24/22"	16"	1	13	22-24	3.7	●	●	
PSU2418	*	24"	0	11 3/4	24	2.4	●	●	●
PSU2420	*	24"	0	11 3/4	24	2.9	●	●	
PSU2422	*	24"	0	11 3/4	24	3.1	●	●	
PSU2424	*	24"	0	11 3/4	24	3.5	●	●	

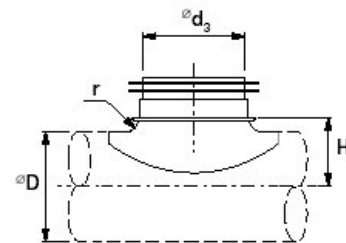

\*Fabricated. Others die-stamped

## Saddle Taps

### Model PSVU

► Die stamped with radiused entry.

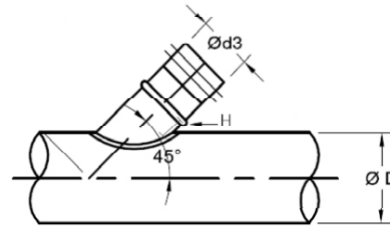

ACP Part Number	ØD (in)	Ød <sub>3</sub> (in)	H (in)	For Spiral Pipe ØD (in)	Wt (lbs.)	Cle	Col	Tol
PSVU33	3"	3"	2 3/8	4	0.2	●		
PSVU44	4"	4"	2 5/8	4	0.5	●		
PSVU64	6"	4"	3 3/4	6	0.4	●		
PSVU66	6"	6"	4	6	0.7	●		
PSVU84	8"	4"	4 1/2	7-8	0.5	●		
PSVU86	8"	6"	4 7/8	7-8	0.7	●		
PSVU88	8"	8"	5	8	1.4	●		
PSVU106	10"	6"	5 7/8	9-10	0.8	●		
PSVU1010	10"	10"	6	9-10	1.2	●		
PSVU128	12"	8"	7 1/8	12	1.1	●		
PSVU1212	12"	12"	7 1/8	12	2.7	●		
PSVU148	14"	8"	8	14	1.5	●		
PSVU1414	14"	14"	8 1/2	14	2.0	●		

*\*Fabricated. Others die-stamped*

# Take-offs/Balancing Dampers

## Model ILU Take Off

- Take-off/starting collar
- To be installed on flat side, i.e. rectangular duct or plenum.

ACP Part Number	$\varnothing d_1$ Diameter	Weight (lbs.)	Cle	Col	Tol
ILU3	3"	0.2	●		
ILU18	18"	1.5	●	●	●
ILU20	20"	1.8	●	●	●
ILU22	22"	2.0	●	●	●
ILU24	24"	2.2	●	●	●
ILU26	26"	2.5	●		●
ILU28	28"	3.1	●		●
ILU30	30"	3.9	●		●

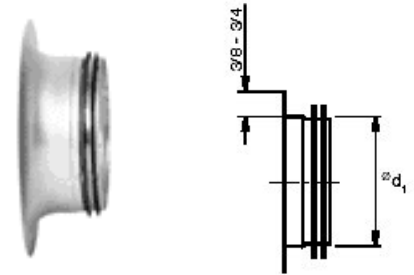

## Model ILRU Take-Off

- Radiused bellmouth take-off
- To be installed on flat side, i.e. rectangular duct or plenum.

ACP Part Number	$\varnothing d_1$ Diameter	r = L (in)	Weight (lbs.)	Cle	Col	Tol
ILRU4	4"	5/8	0.4	●	●	●
ILRU6	6"	7/8	0.7	●	●	●
ILRU8	8"	1	0.7	●	●	●
ILRU10	10"	1	1.1	●	●	●
ILRU12	12"	1	1.3	●	●	●
ILRU14	14"	1	1.6	●	●	●
ILRU16	16"	1	2.0	●	●	●

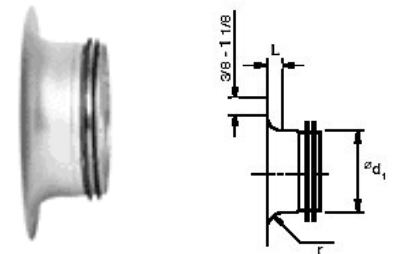

## Model DSU Balancing Damper

- 2" sheet metal insulated stand off
- Integral shaft-blade assembly

ACP Part Number	$\varnothing d_1$ Diameter	L1 (in)	Weight (lbs.)	Cle	Col	Tol
DSU4	4"	4	1.1	●	●	●
DSU6	6"	4	1.5	●	●	●
DSU8	8"	4	2.2	●	●	●
DSU10	10"	4	3.3	●	●	●
DSU12	12"	4	4.0	●	●	●
DSU14	14"	4	5.1	●	●	●

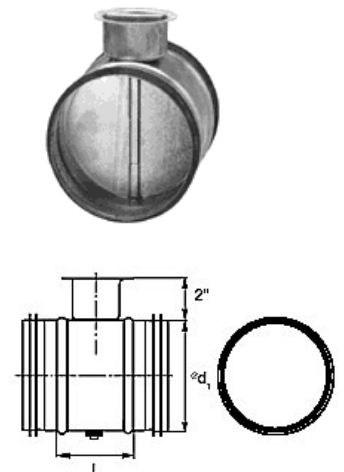



## Hangers & Accessories

### Loop End Fixing



ACP Part Number	Size	Cable Length	Cle	Col	Tol
1LOOP10	No. 1 Safe Working Load 22 lbs. Loop	10 ft.	●		●
2LOOP5	No. 2 Safe Working Load 100 lbs. Loop	5 ft.	●	●	●
2LOOP10		10 ft.	●	●	●
2LOOP15		15 ft.	●	●	●
2LOOP20		20 ft.			●
2LOOP30		30 ft.	●		●
3LOOP5	No. 3 Safe Working Load 200 lbs. Loop	5 ft.	●	●	●
3LOOP10		10 ft.	●	●	●
3LOOP15		15 ft.	●	●	●
3LOOP30		30 ft.	●		●

### Model Stud End Fixing

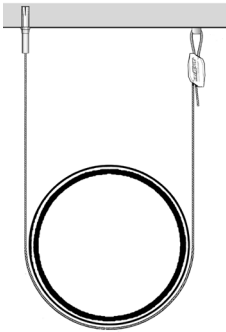

ACP Part Number	Size	Cable Length	Cle	Col	Tol
1STUD10	No. 1 Safe Working Load 22 lbs. Stud	10 ft.	●		
2STUD5	No. 2 Safe Working Load 100 lbs. Stud	5 ft.	●	●	
2STUD10		10 ft.	●	●	●
2STUD15		15 ft.	●		●
3STUD5	No. 3 Safe Working Load 200 lbs. Stud	5 ft.	●		
3STUD10		10 ft.	●		●
3STUD15		15 ft.	●		●

### Trapeze #2



ACP Part Number	Description	Cle	Col	Tol
2TRAPEZE5	No. 2 Trapeze Loop 5 ft.	●		
2TRAPEZE10	No. 2 Trapeze Loop 10 ft.	●		
2LOOPTRAPEZE5	#2 Duct Trapeze Loop End	●		
2LOOPTRAPEZE10	#2 Duct Trapeze Loop End	●		

### Cable Cutting Tool

ACP Part Number	Description	Cle	Col	Tol
Cutter	Cable Cutting Tool	●	●	●
Key	Easy Grip Release Key	●		●

## Rope & Fasteners

### Bulk Wire Rope-Galvanized



ACP Part Number	Description	Cle	Col	Tol
ROP-2MM-500FT-Reel	500' Spool #2 Cable	●	●	

### Replacement Gripples



ACP Part Number	Description	Cle	Col	Tol
XP2-10BB	Express Lock #2	●	●	
HF2-10BB	Standard Lock	●	●	

### Fasteners



ACP Part Number	Description	Cle	Col	Tol
DT2-ACC	Duct Trapeeze Lock	●		

## Spiral Pipe Access Doors & Duct Sealer

---

### Single Wall Pipe Access Door

- ▶ Formed 20 ga. metal plates
- ▶ Polyfoam insulation
- ▶ Steel bolt
- ▶ Steel compression springs
- ▶ Closed cell neoprene gasket



ACP Part Number	Size	Cle	Col	Tol
RAD1066	10 x 6 x 6	●	●	●
RAD1068	10 x 6 x 8	●	●	●
RAD10610	10 x 6 x 10	●	●	●
RAD10612	10 x 6 x 12	●	●	●
RAD10614	10 x 6 x 14	●	●	●

### Duct Sealant and Tape

- ▶ Fire resistive, water based, indoor/outdoor
- ▶ Color: Gray
- ▶ Drying Time: Set to Touch: 1 hour  
Dry Thoroughly: 16 hours



ACP Part Number	Description	Unit of Measure	Cle	Col	Tol
FRSUPERSEAL	Water Base Duct Sealer	1 gallon pail	●	●	
TAPE47	Flex Seal 2"x6	1-Roll		●	

## Access Doors

### Model 9TM

- *Drywall Access Door*
- *Door: 14 Ga. cold-rolled steel*
- *Frame: 16 Ga. cold-rolled steel with 1" flange*
- *Concealed spring hinge (opens to 175°)*
- *Screwdriver cam latch*
- *Phosphate dipped & prime coated finish*

ACP Part Number	Size	Cle	Col	Tol
9TM88	8 x 8	●		
9TM1010	10 x 10	●		
9TM1212	12 x 12	●		
9TM1818	18 x 18	●		
9TM2424	24 x 24	●		

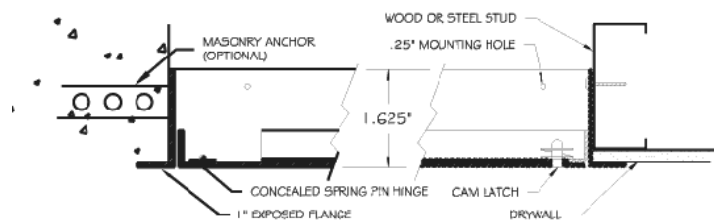

### Framed Duct Access Doors

- *Cammed*
- *Spot-welds at each corner for increased strength*
- *Contains a high density, closed cell gasket for a good seal*

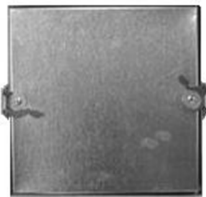

ACP Part Number	Size	Cle	Col	Tol
FDC66	6 x 6	●	●	●
FDC88	8 x 8	●	●	●
FDC1010	10 x 10	●	●	●
FDC1212	12 x 12	●	●	●
FDC1414	14 x 14	●	●	●
FDC1616	16 x 6	●	●	●
FDC1818	18 x 18	●	●	●
FDC2424	24 x 24	●	●	●

### Framed Duct Access Doors

- *Hinged*
- *Spot-welds at each corner for increased strength*
- *Contains a high density, closed cell gasket for a good seal*



ACP Part Number	Size	Cle	Col	Tol
FDH66	6 x 6		●	
FDH88	8 x 8		●	
FDH1010	10 x 10		●	
FDH1212	12 x 12		●	
FDH1414	14 x 14		●	
FDH1616	16 x 6		●	
FDH1818	18 x 18		●	
FDH2424	24 x 24		●	

## Snaplock Pipe & Fittings

### Model #1008

- *Pipe*
- *60" Length – 26 gauge*
- *No tools required.*
- *Self-starting, knurled sufficiently so that the crimp "falls in" and once assembled completes a rigid, leak proof connection*



ACP Part Number	Size	Cle	Col	Tol
26 Gauge				
100860426	4"	●	●	
100860626	6"	●	●	
100860826	8"	●	●	
1008601026	10"	●	●	
1008601226	12"	●	●	
1008601426	14"	●	●	
1008601626	16"	●		

### Model #1005

- *90° Adjustable Elbow*
- *26 gauge*



ACP Part Number	Size	Cle	Col	Tol
26 Gauge				
1005326	3"	●		
1005426	4"	●	●	
1005526	5"	●		
1005626	6"	●	●	
1005826	8"	●	●	
10051026	10"	●	●	
10051226	12"	●	●	
10051426	14"	●	●	
10051626	16"	●		
10051826	18"	●		

## Snaplock Pipe & Fittings

### Model #1051

— *Flat Collar-Crimped*



ACP Part Number	Size	Cle	Col	Tol
10516	4"	●		
10515	5"	●		
10516	6"	●		
10517	7"	●		
10518	8"	●		
105110	10"	●		
105112	12"	●		
105114	14"	●		
105116	16"	●		
105118	18"	●		

### Model #1064

— *Round End Cap*



ACP Part Number	Size	Cle	Col	Tol
10644	4"	●		
10645	5"	●		
10646	6"	●		
10647	7"	●		
10648	8"	●		
106410	10"	●		
106412	12"	●		
106414	14"	●		
106416	16"	●		

### Model #1062

— *Tapered Reducer*



ACP Part Number	Size	Cle	Col	Tol
106243	4 x 3	●		
106254	5 x 4	●		
106264	6 x 4	●		
106265	6 x 5	●		
106276	7 x 6	●		
106286	8 x 6	●	●	
106287	8 x 7	●		
1062106	10 x 6	●		
1062108	10 x 8	●	●	
1062109	10 x 9	●		
1062128	12 x 8	●		
10621210	12 x 10	●	●	
10621410	14 x 10	●		
10621412	14 x 12	●		
10621614	16 x 14	●		
10621816	18 x 16	●		



## Snaplock Pipe & Fittings

---

### Model #1066

— One Quad Damper

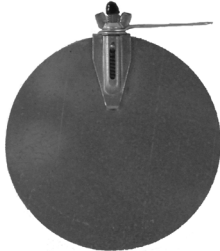

ACP Part Number	Size	Cle	Col	Tol
10664	4"	●		
10665	5"	●		
10666	6"	●		
10667	7"	●		

### Model #1067

— Two Quad Damper

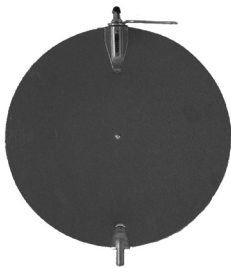

ACP Part Number	Size	Cle	Col	Tol
10678	8"	●		
106710	10"	●		
106712	12"	●	●	
106714	14"	●	●	
106716	16"	●		

### Model #1059

— Tee Joint

— 26 Gauge

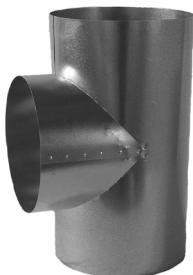

ACP Part Number	Size	Cle	Col	Tol
10596	6 x 6 x 6	●	●	
10598	8 x 8 x 8	●	●	
105910	10 x 10 x 10	●	●	
105912	12 x 12 x 12	●	●	
105914	14 x 14 x 14	●		
105916	16 x 16 x 16	●		
105918	18 x 18 x 18	●		

## Snaplock Pipe & Fittings

---

### Model #EP13

— Adjustable Take Off



ACP Part Number	Size	Cle	Col	Tol
EP136	6"	●		
EP138	8"	●		
EP1310	10"	●		
EP1312	12"	●		
EP1314	14"	●		

### Model #1070

— Chimney Cap



ACP Part Number	Size	Cle	Col	Tol
10706	6"	●		
10708	8"	●		
107010	10"	●		
107012	12"	●		

### Model #ATDRP

— Saddle Tap with dampers

— Stick on gasket



ACP Part Number	Size		Cle	Col	Tol
ATDRP6	6"	6" Tap w/damper on 8, 10, 12	●		●
ATDRP8	8"	8" Tap w/damper on 10, 12, 14	●		●
ATDRP10	10"	10" Tap w/damper on 12, 14, 16, 18	●		●
ATDRP12	12"	12" Tap w/damper on 16, 18	●		●
ATDRP14	14"	14" Tap w/damper on 16, 18	●		

## Snaplock Pipe & Fittings

### Model #1057

#### ➤ Storm Collar



ACP Part Number	Size	Cle	Col	Tol
10573	3"	●		
10574	4"	●		
10575	5"	●		
10576	6"	●		
10577	7"	●		
10578	8"	●		
105710	10"	●		
105712	12"	●		
105714	14"	●		

### Model #1071T

#### ➤ Tall Cone Flashing



ACP Part Number	Size	Cle	Col	Tol
1071T4	4"	●		
1071T5	5"	●		
1071T6	6"	●		
1071T7	7"	●		
1071T8	8"	●		
1071T10	10"	●		
1071T12	12"	●		
1071T14	14"	●		

### Blast Gates

- Full cut off
- Cast aluminum with galvanized steel slide gate
- Set screw to firmly hold blade for volume control



ACP Part Number	Size	Cle	Col	Tol
C1022	2"	●		
C1032	3"	●		
C1042	4"	●		
C1052	5"	●		
C1062	6"	●		
C1072	7"	●		
C1082	8"	●		
C1092	9"	●		
C1102	10"	●		
C1122	12"	●		

## Flexible Duct

### **Model UPC #50**

- **Uninsulated Flex**
- *U.L. 181, Class 1 Air Connector, constructed of a triple lamination of metalized polyester, aluminum foil and polyester, encapsulating a steel wire helix.*



ACP Part Number	Size	Cle	Col	Tol
UPC503	3"	●		
UPC504	4"	●		
UPC505	5"	●		
UPC506	6"	●		
UPC508	8"	●		
UPC5010	10"	●		
UPC5012	12"	●		
UPC5014	14"	●		
UPC5016	16"	●		

Rated Positive pressure	10" w.g. per U.L. 181
Recommended Operating Pressure	6" w.g. pos., all dia.; 3/4" neg., all dia.
Maximum Velocity	5,000 FPM
Flame Spread/Smoke Developed	Less than 25/Less than 50

### **Model UPC #70**

- **Insulated Flex**
- *Durable, all-purpose product UPC 70 is double ply, gray polyester vapor barrier with spiral reinforcements.*
- *R-Value =4.2\**



ACP Part Number	Size	Cle	Col	Tol
UPC704	4"	●		
UPC705	5"	●		
UPC706	6"	●		
UPC708	8"	●		
UPC7010	10"	●		
UPC7012	12"	●		
UPC7014	14"	●		
UPC7016	16"	●		
UPC7018	18"	●		
UPC7020	20"	●		

Rated Positive pressure	10" w.g. per U.L. 181
Recommended Operating Pressure	6" w.g. pos., 4"-12" dia., 4" w.g. pos., 14"-20" dia.; 3/4" w.g. neg., all dia.
Maximum Velocity	5,000 FPM
Flame Spread/Smoke Developed	Less than 25/Less than 50

\*R-Values are classified by Underwriters Laboratories, Inc. in accordance with the ADC flexible Duct Performance and Installation Standards (1991) using ASTM C – 518 at installed wall thickness on flat insulation only.

## Flexible Duct

### Type 3 NI (formerly NI-35) Non-Insulated Flex



UL 181, Class 1 non-insulated connector for application in low to high pressure systems. Solid mechanical union of trilaminated aluminum foil, fiberglass, and aluminized polyester liner and corrosion resistant galvanized steel helix create an extraordinary durable seam.

- ▶ **Working Pressure:** -5" w.g. (-1" w.g. 18" and above) to + 16" w.g.
- ▶ **Minimum Burst Pressure:** 2 ½ times working pressure
- ▶ **Rated Velocity:** 5,500 fpm
- ▶ **Operating Temperature:** -20 to 250 ° Fahrenheit
- ▶ **Standard Length:** 25 feet

ACP Part Number	Size	Cle	Col	Tol
NI354	4"		●	
NI355	5"		●	
NI356	6"		●	
NI357	7"		●	
NI358	8"		●	
NI359	9"		●	
NI3510	10"		●	
NI3512	12"		●	
NI3514	14"		●	

### Thermafex Model KM

*Thermafex KM is thermally insulated, fully lined, UL 181 Class 1 flexible air duct with metallized film laminate outer vapor barrier*

- ▶ **R-Value = 6.0**

ACP Part Number	Size	Cle	Col	Tol
KM4	4"		●	
KM6	6"		●	
KM8	8"		●	
KM10	10"		●	
KM12	12"		●	
KM14	14"		●	
KM16	16"		●	

Rated Pressure	Positive = 10.0 " (4-16 in. ID), 6"0 (18-20 in. ID) Negative = 0.5" (4-20 in. ID)
Maximum Velocity	5,000 FPM
Flame Spread/Smoke Developed	Less than 25/Less than 50

## Flexible Duct

### Model UPC #30

- *Insulated Flex*
- *U.L. 181, Class 1 Air Connector, constructed of a double lamination of metalized polyester, aluminum foil and polyester, encapsulating a steel wire helix.*
- *R-Value =4.2\**



ACP Part Number	Size	Cle	Col	Tol
UPC306	6"	●		
UPC308	8"	●		
UPC3010	10"	●		
UPC3012	12"	●		
UPC3014	14"	●		
UPC3016	16"	●		

Rated Positive pressure	10" w.g. per U.L. 181
Recommended Operating Pressure	4" w.g. pos., all dia.; 3/4" neg., all dia.
Maximum Velocity	5,000 FPM
Flame Spread/Smoke Developed	Less than 25/Less than 50

### Model UPC #10

- *Duct Sleeve*
- *Thick fiberglass insulation for thermal efficiency*
- *Reinforced metalized vapor barrier jacket*
- *5' sections eliminate in shop & jobsite cutting*
- *R-Value =4.2\**

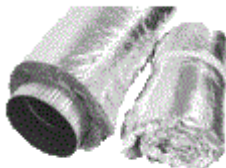

ACP Part Number	Size	Cle	Col	Tol
UPC106	6"	●		
UPC108	8"	●		
UPC1010	10"	●		
UPC1012	12"	●		
UPC1014	14"	●		

Operating Temperature	-20 degrees to 250 degrees Fahrenheit
Flame Spread/Smoke Developed	Less than 25/Less than 50

\*R-Values are classified by Underwriters Laboratories, Inc. in accordance with the ADC flexible Duct Performance and Installation Standards (1991) using ASTM C – 518 at installed wall thickness on flat insulation only.



## Flexible Duct

### Type 1M Insulated Flex



UL 181, Class 1 insulated air duct, solid mechanical union of polyethylene inner liner and corrosion resistant galvanized steel helix create an extraordinary durable seam.

Thermally insulated to an R Value of 4.2 with a reinforced metalized protective vapor barrier to suit any application.

- ▶ *Acoustical Attenuation Benefits*
- ▶ *Working Pressure: -4" w.g to +6 w.g.*
- ▶ *Minimum Burst Pressure: 2 ½ times working pressure*
- ▶ *Rated Velocity: 4000 fpm*
- ▶ *Operating Temperature: -20 to 250 ° farenheight*
- ▶ *Standard Length: 25 Feet*

ACP Part Number	Size	Cle	Col	Tol
1M4	4"	●		
1M6	6"	●		
1M8	8"	●		
1M10	10"	●		
1M12	12"	●		
1M14	14"	●		

### Type 3B Insulated Flex



UL 181, Class 1 insulated air duct, solid mechanical union of polyethylene inner liner and corrosion resistant galvanized steel helix create an extraordinary durable seam.

Thermally insulated to an R Value of 4.2 with a reinforced metalized protective vapor barrier to suit any application

- ▶ *Working Pressure: -5" w.g to +16" w.g.*
- ▶ *Minimum Burst Pressure: 2 ½ times working pressure*
- ▶ *Rated Velocity: 5500 fpm*
- ▶ *Operating Temperature: -20 to +250 ° farenheight*
- ▶ *Standard Lengths: 25 feet*

ACP Part Number	Size	Cle	Col	Tol
3B4	4"	●		
3B5	5"	●		
3B6	6"	●		
3B7	7"	●		
3B8	8"	●		
3B9	9"	●		
3B10	10"	●		
3B12	12"	●		
3B14	14"	●		

## Flexible Duct

### Type 5M Low Pressure Insulated Flex



UL 181, Class 1 insulated air duct for application in low to medium pressure systems. Solid mechanical union of trilaminated aluminum foil, fiberglass, and aluminized polyester liner and corrosion resistant galvanized steel helix create an extraordinary durable seam. Thermally insulated to an R Value of 4.2 with a reinforced metalized protective vapor barrier to suit any application.

- ▶ **Working Pressure:** -4" w.g. (-1" w.g. 18" and above) to + 6" w.g.
- ▶ **Minimum Burst Pressure:** 2 ½ times working pressure
- ▶ **Rated Velocity:** 4,000 fpm
- ▶ **Operating Temperature:** -20 to 250° Fahrenheit
- ▶ **Standard Length:** 25 Feet

ACP Part Number	Size	Cle	Col	Tol
5M4	4"		●	
5M5	5"		●	
5M6	6"		●	
5M7	7"		●	
5M8	8"		●	
5M9	9"		●	
5M10	10"		●	
5M12	12"		●	
5M14	14"		●	
5M16	16"		●	
5M18	18"		●	

### Type 3M Hi Pressure Insulated Flex



UL 181, Class 1 insulated air duct for application in low to high pressure systems. Solid mechanical union of trilaminated aluminum foil, fiberglass, and aluminized polyester liner and corrosion resistant galvanized steel helix create an extraordinary durable seam. Thermally insulated to an R Value of 4.2 with a reinforced metalized protective vapor barrier to suit any application.

- ▶ **Working Pressure:** -5" w.g. (-1" w.g. 18" and above) to + 16" w.g.
- ▶ **Minimum Burst Pressure:** 2 ½ times working pressure
- ▶ **Rated Velocity:** 5,500 fpm
- ▶ **Operating Temperature:** -20 to 250° fahrenheit
- ▶ **Standard Lengths:** 25 feet

ACP Part Number	Size	Cle	Col	Tol
3M4	4"		●	
3M5	5"		●	
3M6	6"		●	
3M7	7"		●	
3M8	8"		●	
3M9	9"		●	
3M10	10"		●	
3M12	12"		●	
3M14	14"		●	
3M16	16"		●	
3M18	18"		●	

## Sheet Metal Fittings

---

### Model #FLD SOG

- ▶ *Take Off w/Damper*
- ▶ *26 ga, G-90 galvanized steel prepunched.*
- ▶ *1 ½ wide flange.*
- ▶ *Adhesive neoprene gasket with peel back tape*



ACP Part Number	Size	Cle	Col	Tol
FLD6SOG	6"	●		
FLD7SOG	7"	●		
FLD8SOG	8"	●		
FLD9SOG	9"	●		
FLD10SOG	10"	●		
FLD12SOG	12"	●		
FLD14SOG	14"	●		

### Model #SLD BO3

- ▶ *Wal-Mart Damper*
- ▶ *26 gauge*
- ▶ *9.25" long, only one end crimped*



ACP Part Number	Size	Cle	Col	Tol
SLDBO36	6"	●		
SLDBO38	8"	●		
SLDBO10	10"	●		
SLDBO12	12"	●		
SLDBO14	14"	●		

## Sheet Metal Fittings

---

### Model #STOD BO2

- ▶ *Side Take off with Damper*
- ▶ *26 ga, G-90 galvanized steel prepunched.*
- ▶ *1" wide flange.*
- ▶ *Adhesive gasket*
- ▶ *Two inch build out for damper handle.*



ACP Part Number	Size	Cle	Col	Tol
STODBO6	6"	●		
STODBO8	8"	●		
STODBO10	10"	●		
STODBO12	12"	●		
STODBO14	14"	●		
STODBO16	16"	●		

### Model #FLDE-SOG-90

- ▶ *Take off w/ Damper & 90° Scoop*
- ▶ *Adhesive gasket*
- ▶ *1 ½" Flange*



ACP Part Number	Size	Cle	Col	Tol
FLDESOG906	6"	●		
FLDESOG908	8"	●		
FLDESOG9010	10"	●		
FLDESOG9012	12"	●		
FLDESOG9014	14"	●		
FLDESOG9016	16"	●		
FLDESOG9018	18"	●		

## Sheet Metal Fittings

---

### Conical Take Off w/Damper



ACP Part Number	Size	Cle	Col	Tol
ATDBM4	4"	●		
ATDBM5	5"	●		
ATDBM6	6"	●		
ATDBM7	7"	●		
ATDBM8	8"	●		
ATDBM9	9"	●		
ATDBM10	10"	●		
ATDBM12	12"	●		
ATDBM14	14"	●		

---

## Sheet Metal Fittings

---

### Model #F3SO

- *Square to Round Adapters*
- *Open Corners*
- *Cleveland & Toledo Office Only*
- *Interior Painted Black*



ACP Part #	Size	Cle	Col	Tol
F3SO666	6 x 6 x 6	●		
F3SO886	8 x 8 x 6	●		
F3SO996	9 x 9 x 6	●		
F3SO12126	12 x 12 x 6	●		
F3SO888	8 x 8 x 8	●		
F3SO998	9 x 9 x 8	●		
F3SO10108	10 x 10 x 8	●		
F3SO101010	10 x 10 x 10	●		
F3SO12128	12 x 12 x 8	●		
F3SO121210	12 x 12 x 10	●		
F3SO121212	12 x 12 x 12	●		
F3SO151512	15 x 15 x 12	●		
F3SO151514	15 x 15 x 14	●		
F3SO18186	18 x 18 x 6	●		
F3SO18188	18 x 18 x 8	●		
F3SO181810	18 x 18 x 10	●		
F3SO181812	18 x 18 x 12	●		
F3SO181814	18 x 18 x 14	●		
F3SO181816	18 x 18 x 16	●		
F3SO181818	18 x 18 x 18	●		
F3SO22106	22 x 10 x 6	●		●
F3SO22108	22 x 10 x 8	●		●
F3SO221010	22 x 10 x 10	●		●
F3SO22226	22 x 22 x 6	●		●
F3SO22228	22 x 22 x 8	●		●
F3SO222210	22 x 22 x 10	●		●
F3SO222212	22 x 22 x 12	●		●
F3SO222214	22 x 22 x 14	●		●
F3SO222216	22 x 22 x 16	●		●
F3SO222218	22 x 22 x 18	●		



## Sheet Metal Fittings

---

### Model #F3SC

- *Square to Round Adapters*
- Closed Corners
- Columbus Office Only



ACP Part #	Size	Cle	Col	Tol
F3SC665	6 x 6 x 5		●	
F3SC666	6 x 6 x 6		●	
F3SC886	8 x 8 x 6		●	
F3SC888	8 x 8 x 8		●	
F3SC10106	10 x 10 x 6		●	
F3SC10108	10 x 10 x 8		●	
F3SC101010	10 x 10 x 10		●	
F3SC12128	12 x 12 x 8		●	
F3SC121210	12 x 12 x 10		●	
F3SC121212	12 x 12 x 12		●	
F3SC141414	14 x 14 x 14		●	
F3SC22106	22 x 10 x 6		●	
F3SC22108	22 x 10 x 8		●	
F3SC221010	22 x 10 x 10		●	
F3SC22226	22 x 22 x 6		●	
F3SC22228	22 x 22 x 8		●	
F3SC222210	22 x 22 x 10		●	
F3SC222212	22 x 22 x 12		●	
F3SC222214	22 x 22 x 14		●	
F3SC222216	22 x 22 x 16		●	
F3SC222218	22 x 22 x 18		●	

## Bath Fans

### Model # A110

- ▶ **Bathroom Vent Fan**
- ▶ **110 CFM 4.0 Sones**
- ▶ *Centrifugal blower wheel and 4-pole motor delivers high exhaust capacity at low sound levels.*
- ▶ *Designer styled white polymeric grille compliments virtually any décor.*

ACP Part Number	Outlet Size	Cle	Col	Tol
676	4"	●		

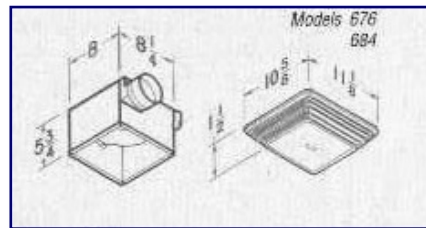

### Model # 679L

- ▶ **Bathroom Vent Fan with Light**
- ▶ **70 CFM 3.5 Sones**
- ▶ *Bright 100 watt lighting capacity (bulb not included).*
- ▶ *Shatter resistant light diffusing lens*
- ▶ *Type IC (insulation contact)*
- ▶ *UL listed for use over bathtubs*

ACP Part Number	Outlet Size	Cle	Col	Tol
679	4"	●		

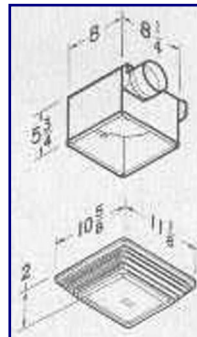

*and showers*



### Model # A80

- ▶ **Bathroom Vent Fan**
- ▶ **80 CFM 2.5 Sones**
- ▶ *Centrifugal blower wheel and 4-pole motor deliver high exhaust capacity at low sound levels.*
- ▶ *Designer styled white polymeric grille compliments virtually any décor.*

ACP Part Number	Outlet Size	Cle	Col	Tol
684	4"	●		

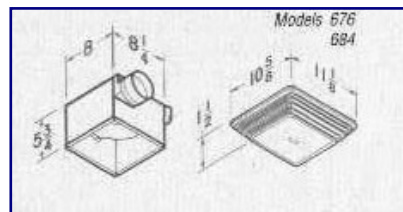

### Model # 689

- ▶ **Bathroom Ceiling/Wall Vent Fan**
- ▶ **60 CFM 5.5 Sones**
- ▶ *Torsion spring grille mounting*
- ▶ *No tools necessary.*
- ▶ *Compact housing fits easily between ceiling joists or wall studs.*

ACP Part Number	Outlet Size	Cle	Col	Tol
689	3"	●		

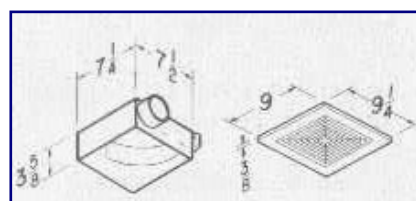

## Wall & Roof Caps

### **Model # 639** Wall Cap

- For 3 1/4" x 10 duct
- Spring loaded backdraft damper
- Built-in bird screen
- Steel baked black enamel finish

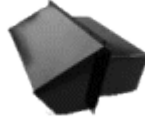

ACP Part Number	Broan Model	Cle	Col	Tol
639	639	●		

### **Model # 642** Wall Cap

- For 3" or 4" round duct
- 4" to 3" Transition included
- Built-in backdraft damper
- Aluminum natural finish



ACP Part Number	Broan Model	Cle	Col	Tol
642	642	●	●	

### **Model # 641** Wall Cap

- For 6" round duct
- Built-in backdraft damper and birdscreen
- Aluminum natural finish



ACP Part Number	Broan Model	Cle	Col	Tol
641	641	●	●	

### **Model # 643** Wall Cap

- For 8" round duct
- Built-in backdraft damper
- Aluminum natural finish



ACP Part Number	Broan Model	Cle	Col	Tol
643	643	●	●	

### **Model # 636** Roof Cap

- For 3" or 4" round duct
- Built-in backdraft damper and birdscreen
- Steel baked enamel finish



ACP Part Number	Broan Model	Cle	Col	Tol
636	636	●		

### **Model # 441** Wall Cap

- 10" for Range Hoods and Bath Fans
- Built-in birdscreen
- 24 Gauge Galvanized Steel



ACP Part Number	Broan Model	Cle	Col	Tol
441	441	●		

### **Model # 613** Wall Cap

- For 12" round duct
- Built-in backdraft damper & birdscreen
- Aluminum Natural Finish



ACP Part Number	Broan Model	Cle	Col	Tol
613	613	●		



eCAPS

**GREENHECK'S**

# eCAPS™ Fan Application Suite

**DESIGNED SPECIFICALLY FOR HVAC ENGINEERS**



## Select and specify fans quicker and easier than ever before.

- Available online – no need to install, always up-to-date
- Mobile-ready – iPad and tablet accessible
- Fast and efficient – easy in, easy out
- Compare multiple models simultaneously
- Fan optimization – based on cost, efficiency and sound performance





# eCAPS™ Fan Application Suite



Greenheck's new eCAPS Fan Application Suite takes the ventilation industry's most trusted selection software, CAPS, to a new level! eCAPS is web-based and utilizes cloud computing for fast and easy selections based on your application. Just go to [ecaps.greenheck.com](http://ecaps.greenheck.com) for FREE access to this amazing new specifying tool.



## Select the right fan for the job at hand.

eCAPS is quick and easy, guiding you through the selection process to ensure you select the best fans for your building projects. Just enter your volume, pressure and elevation...and eCAPS automatically finds and ranks the best fans based on cost and performance. Fine-tune your selection by selecting certifications or special requirements.

## Compare fan models quickly and efficiently.

Whether you want to compare fan performance, sound levels, operating costs or first costs, eCAPS puts that information for all applicable fan models on a single screen for easy comparison.

## Reduce errors.

eCAPS automatically cautions you when your selections are close to maximum fan RPM, when you are close to being unstable and when your selection is under or over your required CFM.

## Easily transfer your selections.

Share or print custom equipment schedules, AutoCAD® and 3-D Revit® content and more.

## Simulate installation performance.

Use eCAPS' System Effect Simulator to see how the fan you select will perform under various inlet and outlet conditions.

## Increase your fan knowledge.

eCAPS' convenient Toolbox is loaded with useful application information about fan performance and the latest fan application technology such as EC motors and airflow monitoring.

## Try eCAPS today. It's easy to access and free!

[ecaps.greenheck.com](http://ecaps.greenheck.com)

Supported Browsers: Internet Explorer 9 (and newer), Google Chrome, Safari, and Firefox

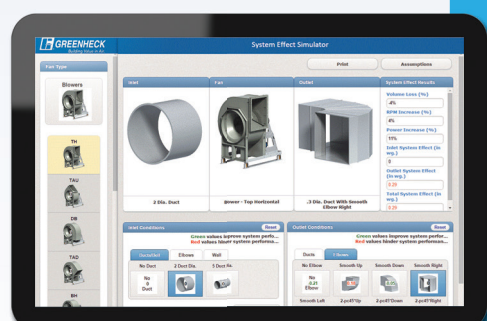
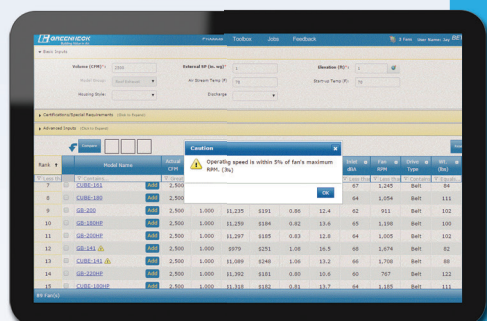
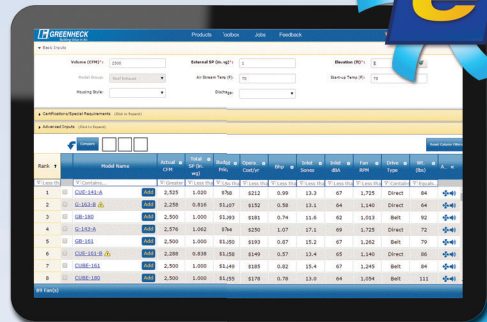

# Roof Exhaust Fans:

## Adjustable G Roof Exhaust Direct Drive Fan

- ▶ Aluminum Housing
- ▶ Non-overloading backward inclined wheel
- ▶ Aluminum curb cap with pre-punched mounting holes
- ▶ Integral hood bead for reinforced strength
- ▶ Galvanized birdscreen
- ▶ Motor isolated on shock mounts
- ▶ Nema-1 disconnect

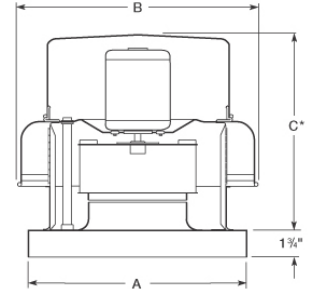
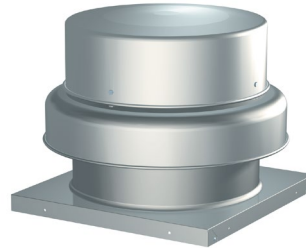

### Dimensional Data

ACP Part #	Model #	A	B	C	Cle	Col	Tol
G095VG	G-095-VG	17	21 3/4	14 5/8	●	●	
<b>CFM 125 thru 1031 @ .25" S.P. adjustable through Vari-Green</b>							
G103VG	G-103-VG	19	24 3/8	23 3/4	●	●	
<b>CFM 250 thru 1510 @ .25" S.P. adjustable through Vari-Green</b>							
G123VG	G-123-VG	19	24 3/8	23 3/4	●	●	
<b>CFM 455 thru 2215 @ .25" S.P. adjustable through Vari-Green</b>							
G133VG	G-133-VG	19	28 3/8	23 3/4	●	●	
<b>CFM 550 thru 2610 @ .25" S.P. adjustable through Vari-Green</b>							
G143VG	G-143-VG	22	28 3/8	23 3/4	●		
<b>CFM 550 thru 3050 @ .25" S.P. adjustable through Vari-Green</b>							

## Model #GB Roof Exhaust Belt Drive Fan

- ▶ Aluminum Housing
- ▶ Non-overloading backward inclined wheel
- ▶ Galvanized birdscreen
- ▶ Integral hood bead for reinforced strength
- ▶ Double studded isolators for true vibration isolation
- ▶ Motor out of air stream
- ▶ Adjustable motor pulleys allow for final system balancing
- ▶ Nema-1 disconnect

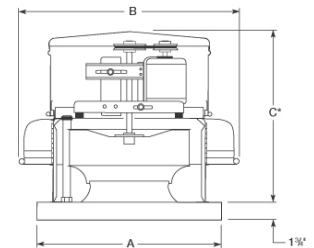

### Dimensional Data

ACP Part Number	Model	A	B	C	Cle	Col	Tol
GB0814XR3	GB-081	19	24 3/8	23 3/4	●		
GB0914XR3	GB-091	19	24 3/8	23 3/4	●		

Model Number	Roof Opening	Min/Max RPM	Sones @ 0 in.	Performance in inches WG									
				0.00	.100	.125	.250	.375	.500	.625	.750	1.00	
GB-081	14 1/2 x 14 1/2	630	2.4	315									
		1710	12.5	856	784	710	629	480					
GB-091	14 1/2 x 14 1/2	660	3.1	500									
		1710	13.4	1295	1179	1061	934	785					

# Ceiling Exhaust Fans:

## Model #SP Ceiling Exhaust Fan

- Model SP exhaust fans are designed for applications where low sound levels are critical.
- They are ideal selections for offices, conference rooms and restrooms.
- Their low sound levels are achieved through quiet running forward curved wheels.
- All model SP fans are UL listed and licensed to bear the AMCA Certified Ratings Seal for air and sound performance.
- Units are stocked with 115/60/1 motors
- Plug in disconnect switch included
- Integral backdraft damper



**SP-B**

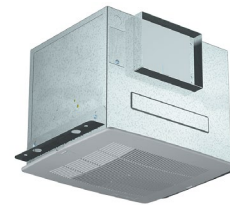

**SP-A**

### Dimensional Data

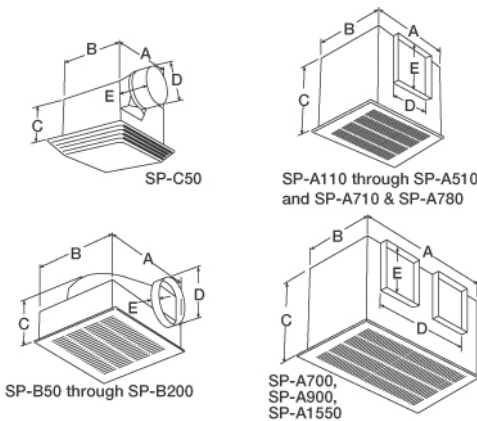

ACP Part Number	A	B	C	Outlet		Cle	Col	Tol
				D	E			
SPB90	13 7/8	11 1/2	7	6	1 1/4		•	
SPB110	13 7/8	11 1/2	7	6 dia.	1 1/4	•	•	•
SPB150	13 7/8	11 1/2	7	6 dia.	1 1/4	•	•	•
SPB200	13 7/8	11 1/2	7	6 dia.	1 1/4	•		•
SPA250	14	11 7/8	11 1/4	8	8		•	
SPA290	14	11 7/8	11 1/4	8	8	•		•
SPA390	14	11 7/8	11 1/4	8	8	•		
SPA410	18	14 3/8	14 1/2	8	8	•	•	
SPA510	18	14 3/8	14 1/2	8	8	•		
SPA710	18	14 3/8	14 1/2	10	8	•		

Model Number	RPM	AMPS	WATTS	Sones @ 0 in.	CFM	Performance in inches WG									
						0.00	.100	.125	.250	.375	.500	.625	.750	1.00	
SP-B110	950	1.14	80	2.0	CFM	133	114	110	97	95	94	91	85	50	
SP-B150	1050	1.70	129	3.0	CFM	160	156	155	154	152	149	147	138	92	
SP-B200	1100	2.20	173	4.4	CFM	197	195	194	191	187	184	181	166	128	
SP-A290	1050	0.72	81	3.2	CFM	315	293	287	257	231	207	175	124		
SP-A390	1350	1.34	135	5.4	CFM	410	395	391	368	345	325	307	279		
SP-A410	1000	1.74	121	4.1	CFM	443	413	405	351	305					
SP-A510	1070	3.30	224	6.0	CFM	557	512	501	439	392	325				
SP-A710	1080	4.40	285	7.4	CFM	752	714	701	653	588	485	320			



## In-Line Fans:

### Model #CSP Cabinet Exhaust Fan

- ▶ *Model CSP inline cabinet fans are designed for clean air applications where low sound levels are desired.*
- ▶ *They can be used for supply, exhaust or return applications within a duct system. Low sound levels are achieved through quiet running forward curved wheels and an acoustically insulated housing.*
- ▶ *The outlet duct includes an integral aluminum back draft damper that is easily converted from horizontal to vertical discharge positions.*
- ▶ *Model CSP fans are UL listed and licensed to bear the AMCA Certified Rating seals for air & sound Performance*
- ▶ *Units are stocked with 115/60/1 motors*

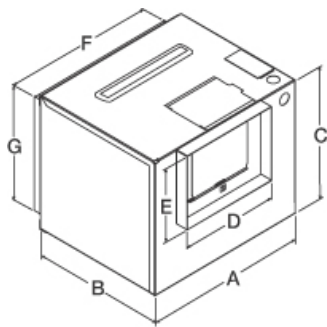
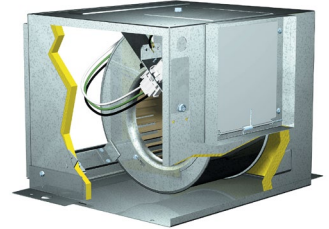

### Dimensional Data

Model	A	B	C	D	E	F	G	Cle	Col	Tol
CSPA190	13 1/4	10 5/8	10 1/2	8	6	12	9 1/4	●		
CSPA250	14	10 7/8	11 1/4	8	8	12 7/8	10	●		●
CSPA390	14	10 7/8	11 1/4	8	8	12 7/8	10	●		●

Model Number	RPM	AMPS	Watts	Performance in inches WG							
				0	.125	.25	.375	.5	.75	1	
CSP-A190	1400	1.10	100	CFM	215	198	180	159	121		
				Sones	2.3	2.2	2.7	2.9	3.0		
CSP-A250	1000	0.79	83	CFM	266	241	221	205	187	132	
				Sones	1.3	1.5	2.3	3.3	3.4	3.0	
CSP-A390	1350	1.33	144	CFM	412	397	382	363	339	309	
				Sones	2.8	2.8	3.2	3.7	4.7	6.5	

## Fan Accessories:

### Model #WD 100 Backdraft Damper

- ▶ Galvanized steel
- ▶ No flange



ACP Part Number	Size	Cle	Col	Tol
WD1001010	10 x 10	●	●	
WD1001212	12 x 12	●	●	
WD1001818	18 x 18	●		

### Model #SSC Solid State Controller

- ▶ For applications up to 5.0 amps
- ▶ For use with shaded pole & open permanent split capacitor motors.
- ▶ Requires 2 x 4 handy box by others.



ACP Part Number	Size	Cle	Col	Tol
SSC05	5-Watt	●	●	●

### Model #VI Kit Vibration Isolator Kit

- ▶ For use in suspended fan installation
- ▶ Fan mounting brackets include pre-punched mounting holes for ease of installation.
- ▶ Kits include all hardware necessary to mount one unit, with the exception of 10-32 threaded rod to be supplied by others.

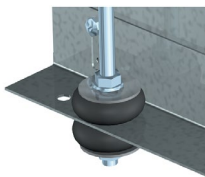

ACP Part Number	Size	Cle	Col	Tol
VIKIT	VI Kit	●		●

### Model # ET5SRS Cooling T-Stat

- ▶ For ¾ H.P. or less

ACP Part Number	Size	Cle	Col	Tol
ET5SRS	¾ HP or less	●	●	●

## Curbs and Pipe Portal System

### Model #RC2A

- 12" & 16" Roof Curb
- 2" Flange
- Wood Nailer

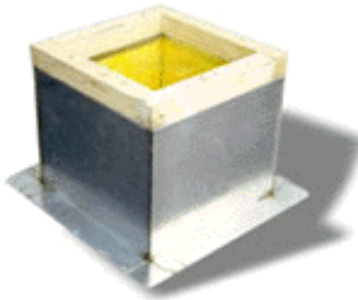

ACP Part Number	Size	Height	Cle	Col	Tol
RC2A12.5	12 ½ x 12 ½	12"	●	●	●
RC2A13.5	13 ½ x 13 ½	12"	●	●	●
RC2A15.5	15 ½ x 15 ½	12"	●	●	●
RC2A17.5	17 ½ x 17 ½	12"	●	●	●
RC2A20.5	20 ½ x 20 ½	12"	●	●	●
RC2A24.5	24 ½ x 24 ½	12"	●	●	●
RC2A27	27 x 27	12"		●	
RC2A28.5	28 ½ x 28 ½	12"	●	●	●
RC2A32.5	32 ½ x 32 ½	12"	●	●	●
RC2A38.5	38 ½ x 38 ½	12"	●	●	●
RC2A44.5	44 ½ x 44 ½	12"	●	●	●
RC2A16H12.5	12 ½ x 12 ½	16"			●
RC2A16H15.5	15 ½ x 15 ½	16"			●
RC2A16H17.5	17 ½ x 17 ½	16"			●
RC2A16H20.5	20 ½ x 20 ½	16"			●
RC2A16H24.5	24 ½ x 24 ½	16"			●

### Pipe Portals



#### N-28

For two 3/8" thru 1" pipes and two 1" thru 2" pipes.

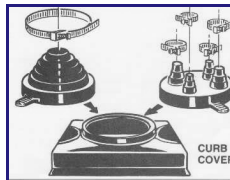

#### Curb Cover

13" x 13" I.D  
Reinforced ABS Plastic cover.

ACP Part Number	Size	Cle	Col	Tol
N28	Cover w/2 sm. & 2 med. Clamps	●	●	●
N-62	Cover with 1 large clamp	●		●
PCC1212	12 ½ x 12 ½ plastic curb cover	●	●	●
PCC5	12 ½ x 12 ½	●		●
Alumiflash	Alumi-flash	●		
RCC7	Roof Cap	●		●



#### N-62

2" thru 6" pipe



Full Pipe Portal assembly shown



Five Hole Portal Cap  
PCC5

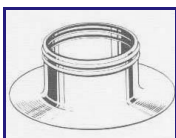

#### Alumi-Flash

Consist of 2 components, the .060 spun aluminum base and the N62 or N28 cover, either can be used.

## Equipment Support Rails

### 12" High Straight Rail

- 2" Base Flange
- 2 x 4 Wood Nailer

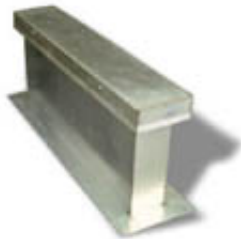

ACP Part Number	Size	Cle	Col	Tol
ER2A121	1'	●	●	
ER2A122	2'	●	●	●
ER2A123	3'	●	●	●
ER2A124	4'	●	●	●
ER2A126	6'	●	●	●
ER2A128	8'	●	●	●
ER2A1210	10'	●		
ER2A1212	12'	●		

\*The Maximum allowable uniform load for the above rails is 860 lbs. /ft.

\* The information above is recommended weight loading information by Roof Products & Systems.

### Canted Rails

- 12" High
- 2" Base Flange
- 2 x 4 Wood Nailer

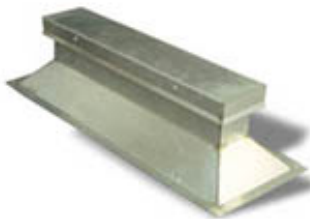

ACP Part Number	Size	Cle	Col	Tol
ER3A1	1'	●		
ER3A2	2'	●		
ER3A3	3'	●		
ER3A4	4'	●		
ER3A6	6'	●		
ER3A8	8'	●		
ER3A10	10'	●		

\*The Maximum allowable uniform load for the above rails is 450 lbs. /ft.

\* The information above is recommended weight loading information by Roof Products & Systems.

### Dektites

- For use with metal roof panels, aluminum, cooper, plastic, fiberglass, lead & wood.
- Flexible aluminum base conforms to any panel.
- Temperature range -30 to +250 F

ACP Part Number	Pipe Dia.	Base Dia.	Cle	Col	Tol
DT-3	1/4" - 4"	7 3/4"	●		
DT-4	3" - 6"	9 1/4"	●		
DT-6	5" - 9"	13 1/2"	●		



## Wall & Baseboard Heaters

### Series 3320TTD-RP Fan Forced Wall Heater



- *Construction: Powder coated 18 ga. steel grille with extruded aluminum front frame.*
  - *Disconnect switch*
  - *Automatic fan delay switch*
  - *Vane axial fan blade – 600 RPM motor – 175 CFM*
- **Rough in dimensions: 14-3/16" W x 19-15/16 H x 4" Deep**
- **Grill Dimensions: 15-29/32" W x 20-27/32" H**

ACP Part Number	Watts	Volts	Factory Model Number	Cle	Col	Tol
3322TTDRP	1000	120V	E3322TTD-RP	•		
3322TTDRP	1125/1500	208/240	HF3323TTD-RP	•		
3324TTDRP	1500/2000	208/240	HF3324TTD-RP	•		
3325TTDRP	2250/3000	208/240	HF3325TTD-RP	•		
3326TTDRP	3000/4000	208/240	HF3326TTD-RP	•		
<b>Wall Heater Accessories</b>						
3310BOX	Rough In Box		Box 3310	•		
3320EX33	Surface Mount Box		3320EX16	•		

### Series 2900 Baseboard Heaters



- *Construction: Powder coated 22 ga. steel front with 20 ga. junction boxes*
  - *Finish: White*
  - *Over-temperature thermal limit extends entire length of heater .*
- *A full-length wireway provided along the back of the heater.*
  - *Height 6" Depth 2 ½"*

ACP Part Number	Watts	Volts	Length	Factory Model Number	Cle	Col	Tol
E2907040A	750	120	40"	E2907-040A	•		
E2910048A	1000	120	48"	E2910-048A	•		
<b>Baseboard Heater Accessories</b>							
TBS	Thermostat			TBS	•		

## Electric Unit Heaters

---

### Series 5100 Electric Unit Heater



- *Construction: Powder coated 18 ga. cabinet with hinged and latched access door*
- *Totally enclosed 1-speed 1 phase permanently lubricated, thermally protected motor with unit bearings.*
- *Louvers are individually adjustable for directional control of air flow up to 15 degree from straight horizontal*
- *Can be mounted for horizontal or vertical discharge. Application up to 6,000 ft.*

ACP Part Number	KW	Volts	Factory Model Number	Cle	Col	Tol
F1F5103N	3.3	208	F1F5103N	●	●	
F1F5105N	5.0	208	F1F5105N	●	●	
<b>Wall Heater Accessories</b>						
A5105	Wall/Ceiling Mounting Bracket		A5105	●	●	
3320EX33	Surface Mount Box		3320EX16	●	●	
T5100	SPST Line Voltage T-Stat		T5100	●	●	
DCS202	Power Disconnect Switch (5103)		DSC202	●	●	
DSC403	Power Disconnect Switch (5105)					



## Louvers & Brick Vents

### Stationary Louver

- ▶ **Frame:** 4" Deep Channel  
.081" Thick 6063-T5 Extruded Aluminum Alloy
- ▶ **Blades:** 45 degree J Blade  
.081" Thick 6063-T5 Extruded Aluminum Alloy
- ▶ **Screen:** Interior, 1/2" removable expanded aluminum bird screen
- ▶ **Finish:** Mill

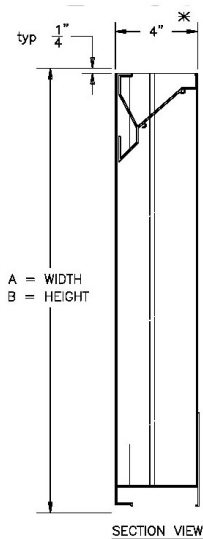

ACP Part Number	Size	Cle	Col	Tol
ESJ4011212	12 x 12	●		
ESJ4012412	24 x 12	●		
ESJ4012424	24 x 24	●		
ESJ4013624	36 x 24	●		
ESJ4013636	36 x 36	●		
ESJ4014848	48 x 48	●		

### Model BEX

- ▶ **Brick/Block Masonry Vents**
- ▶ **Frame:** 4" Deep .125" Extruded Aluminum
- ▶ **Blades:** Extruded Aluminum, appx. spacing is 1" @ 45 degrees
- ▶ **Screen:** Aluminum mesh insect screen
- ▶ **Mullions:** Visible
- ▶ **Finish:** Mill

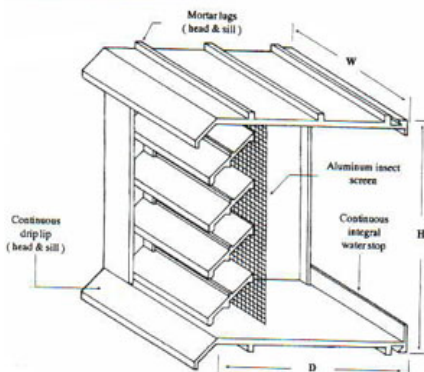

ACP Part Number	Minimum Opening Req.	Nominal Size	Size	Cle	Col	Tol
EX847	8 3/4 x 5 1/4	8 1/8 x 4 3/4	8 x 4	●		
EX125	12 1/4 x 5 1/4	12 x 4 3/4	12 x 4	●		
EX128	12 1/4 x 8 1/4	12 x 7 3/4	12 x 8	●		
EX168	16 3/4 x 8 1/4	16 1/2 x 7 3/4	16 x 8	●		



## Horizontal Fire Dampers

### Model FD150H

- ▶ **Frame Construction:** One-piece roll formed 22 ga. galvanized steel
- ▶ **Blade Construction:** 22 Ga. Galvanized steel curtain-type
- ▶ **Fusible Link:** UL listed 165°F; replaceable.

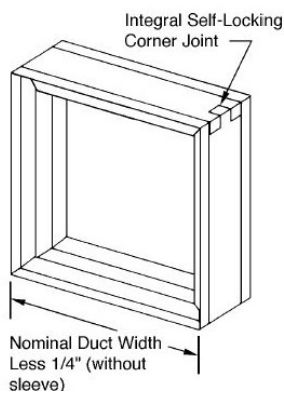

ACP Part Number	Size	Cle	Col	Tol
FD15066	6 x 6	●		
FD15088	8 x 8	●		
FD15099	9 x 9	●		
FD1501010	10 x 10	●		
FD150128	12 x 8	●		
FD1501212	12 x 12	●		
FD1501410	14 x 10	●		
FD1501412	14 x 12	●		
FD150168	16 x 8	●		
FD1501612	16 x 12	●		
FD1501810	18 x 10	●		
FD1501812	18 x 12	●		
FD1501818	18 x 18	●		
FD1502010	20 x 10	●		
FD1502012	20 x 12	●		
FD1502210	22 x 10	●		
FD1502222	22 x 22	●		
FD1502412	24 x 12	●		
FD1502424	24 x 24	●		

### Model FD150- Round

- ▶ **Frame Construction:** One-piece roll formed 22 ga. galvanized steel
- ▶ **Blade Construction:** 22 Ga. Galvanized steel curtain-type
- ▶ **Fusible Link:** UL listed 165°F; replaceable.

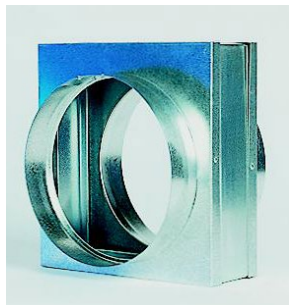
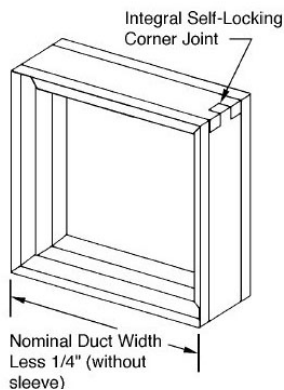

ACP Part Number	Size	Cle	Col *	Tol
FD1506	6"Ø	●		
FD1508	8"Ø	●		
FD15010	10"Ø	●		
FD15012	12"Ø	●		
FD15014	14" Ø			

### Fusible Links



ACP Part Number	Degree	Cle	Col	Tol
165CLE	165°	●	●	
212CLE	212°	●		

## Dynamic Rated Fire & Radiation Dampers

### Model DFD150

- **Dynamic Rated Fire Damper**
- *12" 20 Ga. Sleeve*
- *Horizontal Mounting*
- *Retaining Angles – 2 side loose*
- *165 degree Fusible Link*



ACP Part Number	Outlet Size	Sleeve Size	Cle	Col	Tol
DFD150X6	6" Ø	12"		●	
DFD150X8	8" Ø	12"		●	
DFD150X10	10" Ø	12"		●	
DFD150X12	12" Ø	12"		●	
DFD150X14	14" Ø	12"		●	

### Model CRD-2

- **Round Radiation Damper**
- *Frame Construction: One-piece roll formed 22 ga. Galvanized steel*
- *Blade Construction: 22 Ga. Galvanized steel*
- *Fusible Link: UL listed 165°F*
- *Spring Extension type*
- *Finish: Mill*

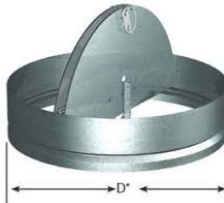

ACP Part Number	Outlet Size	Cle	Col	Tol
CRD26	6" Ø	●		
CRD28	8" Ø	●		
CRD210	10" Ø	●		
CRD212	12" Ø	●		
CRD214	14" Ø	●		

### Model CRD-60

- **Square Ceiling Radiation Dampers**
- *Frame Construction: One-piece roll formed 22 ga. Galvanized steel*
- *Tightly woven reinforced fiberglass fabric with aluminum impregnated fully sealed coating*
- *Stainless steel negator springs*
- *Fusible Link: UL listed 165°F*
- *Fabric riveted to blade; no adhesive used*



ACP Part Number	Outlet Size	Cle	Col	Tol
CRD602222	22 x 22	●		
CRD602210	22 x 10	●		

### Radiation Blanket

- **1/4" Thick ceramic fiber**

ACP Part Number	Outlet Size	Cle	Col	Tol
RB693058	24 x 24	●		

## Duct Smoke Detectors

### Model # D4120 ACDCI Duct Smoke Detector



The System Sensor Innovair™ *D100ACDCI* is a 4-wire ionization air duct smoke detector capable of sensing smoke in air velocities from 500 to

4,000 feet per minute. This detector was developed to constantly monitor the air within a duct and to detect the presence of smoke.

ACP Part Number	Mfg. Model	Cle	Col	Tol
D4120	D4120	●		
DST1.5	1'-2' Sampling Tube	●		
DST3	2'-4' Sampling Tube	●		
DST5	4'-8' Sampling Tube	●		

The Innovair family is designed for simplified installation and easy maintenance. The modular construction allows for easy cleaning and uncomplicated field replacement of the UL recognized power and sensor boards.



**Model APA 151**  
*Remote Annunciator with alarm*

ACP Part Number	Mfg. Model	Cle	Col	Tol
APA151	APA151	●		
RTS151	RTS151	●		
RTS151	RTS151 Key	●		



**Model RTS151**  
*Magnetic Test/Reset Station*



**Model RTS151Key**  
*Key Remote Test/Reset Station*

### Model # RTS2- Key Test Annunciator



The System Sensor RTS2 multi-signaling accessory is designed for use with System Sensor D100ACDC duct smoke detector models and combines a horn feature with the key activated test and reset functions. Green, amber, and red LED's provide visual indication of power, trouble and alarm conditions.

ACP Part Number	Mfg. Model	Cle	Col	Tol
RTS2	RTS	●		
AOS	AOS	●		



*Optional: AOS Strobe*

## Draw Bands, Tool & Eggcrate

- *36" White Draw Bands*
- *43" Orange Draw Bands*
- *Tensioning Tool*

ACP Part Number	Size	Cle	Col	Tol
T150LL	36" Bands	●	●	●
T150XL	43" Bands	●	●	●
T150	Tension Tool	●	●	●

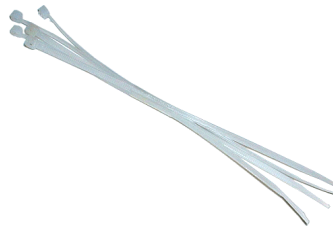

### Eggcrate

- *Eggcrate-Aluminum & Plastic*

ACP Part Number	Size	Material	Cle	Col	Tol
EGGCRATE2448A	24 x 48	Aluminum	●		
EGGCRATE2448P	24 x 48	Plastic	●		

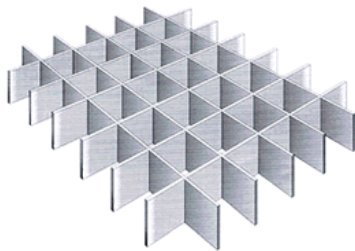

## **Loudness**                      **\*Suggested HVAC Guidelines**

---

### **Suggested Limit For Room Loudness**

<b>Sones</b>	<b>DBA</b>	<b>Occupancy</b>
1.3 – 4.0	32 - 48	<i>Private homes (rural &amp; suburban)</i>
1.7 – 5.0	36 - 51	<i>Conference rooms</i>
2.0 – 6.0	38 - 54	<i>Hotel rooms, libraries, movie theaters, executive offices</i>
2.5 – 8.0	41 - 58	<i>Schools &amp; classrooms, hospital wards &amp; operating rooms</i>
3.0 – 9.0	44 - 60	<i>Court rooms, museums, apartment houses and private homes (urban)</i>
4.0 – 12.0	48 - 64	<i>Restaurants, lobbies, general open offices &amp; banks</i>
5.0 – 15.0	51 - 67	<i>Corridors &amp; halls, cocktail lounges, washrooms &amp; toilets</i>
7.0 – 21.0	56 - 72	<i>Hotel kitchens and laundries, supermarkets</i>
12.0 – 36.0	64 - 80	<i>Light machinery, assembly lines</i>
15.0 – 50.0	67 - 84	<i>Machine shops</i>
25.0 – 60.0	74 – 87	<i>Heavy machinery</i>

*From AMCA Publication 302*

*Note: Values above are for room loudness and are not sound ratings.*

*Room loudness is the resulting level in a conditioned space after the acoustical qualities of the room have been accounted for.*

---

### **Criteria for Acceptable HVAC Noise Levels In Unoccupied Rooms**

<b>NC</b>	<b>Occupancy</b>
15 - 20	<i>Concert and recital halls and recording studios</i>
20 - 25	<i>TV studios</i>
25 - 30	<i>Private residences, executive offices, conference rooms, hospital operating rooms and school lecture and classrooms</i>
30 - 35	<i>Apartments, hotel meeting rooms, private offices, hospital corridors &amp; movie theaters</i>
35 - 40	<i>Hotel halls, corridors and lobbies, hospital laboratories and public areas, libraries &amp; courtrooms</i>
40 - 45	<i>Office computer rooms and restaurants</i>
45 - 50	<i>Gymnasiums, supermarkets, post offices, locker rooms, laundries and bowling alleys</i>
50 - 75	<i>Warehouses, hangars, skating rinks, factories, machine shops and steel mills</i>

## Ventilation *\*Suggested HVAC Guidelines*

### Fundamental Requirements for General Ventilation

*The intention of this article is to give you some basic formulas and guidelines for a proper general ventilation system. The objectives of a proper system are to remove hot, stale or stagnant air from the environment or to supply cooler, fresher air to the environment.*

*There are multiple methods of calculating the approximate required volume that is needed for a facility. We will discuss a couple of the basic methods.*

### Air Change Method

*For personal comfort, this method works best if the facility is not over 100 feet in length and not greater than 50,000 cubic feet in capacity. For larger buildings, booster/circulator fans may be required.*

**CFM = AREA TO BE VENTILATED (cubic feet) / Rate of Air Change (minutes)**

*For the suggestions of air changes per number of minutes refer to the following chart:*

Type of facility	Minute / A.C.	Type of Facility	Minutes / A.C.
Assembly Halls	3 - 10	Laundries	2 - 5
Auditoriums	4 - 10	Locker Rooms	2 - 5
Bakeries	1 - 3	Machine Shops	3 - 5
Banks	3 - 10	Mills (paper)	2 - 3
Beauty Parlors	2 - 5	Mills (Textile)	3 - 15
Boiler Rooms	2 - 4	Offices	2 - 8
Bowling Alleys	2 - 8	Packing Houses	2 - 5
Churches	4 - 15	Production Rooms	1 - 2
Corridors	6 - 20	Projection Rooms	1 - 3
Dry Cleaners	1 - 5	Recreation Rooms	2 - 8
Engine Rooms	1 - 2	Residences	2 - 5
Factory (Gen Vent)	5 - 10	Restaurants	5 - 10
Factory (fumes)	1 - 5	Retail Stores	3 - 10
Forge Shops	1 - 2	Sales Rooms	3 - 10
Foundries	1 - 4	Shops (Gen Vent)	3 - 10
Garages (Repair)	2 - 10	Stores	5 - 10
Generating Rooms	2 - 5	Theaters	3 - 8
Glass Hants	1 - 2	Toilets	2 - 5
Gymnasiums	2 - 10	Transformer Rooms	1 - 5
Heat Treat Rooms	½ - 1	Waiting Rooms	10
Kitchens	1 - 3	Warehouses	2 - 10





**Greenheck**  
Make up air, DOAS systems,  
Laboratory fans, Life Safety  
Dampers, Louvers, Fans  
CLE, COL, TOL



**Price**  
Air devices, Terminal units,  
Underfloor systems, Silencers,  
Chilled beams, Radiant systems,  
Operating rooms, Ceilings, Controls  
CLE, COL, TOL



**Markel**  
Electric Heat of all types,  
Wall, Baseboard, Ceiling, Duct,  
Radiant, Unit, Fan coils  
CLE, COL, TOL



**linx**  
Self-sealing Gasketed  
Single Wall & Double  
Wall Spiral Pipe &  
Fittings, Registers  
CLE, COL, TOL

**Monoxivent**  
Vehicle & Welding Exhaust Capture  
Systems, Portable Exhaust Systems,  
Custom Exhaust Systems, FRP Duct-  
work  
CLE, COL, TOL



**Acutherm by Price**  
VAV Diffusers, Therma-Fuser  
Systems  
CLE, COL, TOL



**Armstrong Monitoring**  
Hazardous gas and Liquid Leak  
Detection Specialists  
CLE, COL, TOL



**American Air Filter**  
Medium & High Efficiency Filters,  
Housings, Clean Room filters &  
Systems, Pollution & Dust Control  
CLE, COL, TOL



**Duct Sox**  
Fabric duct, Custom  
Designed and Engi-  
neered Fabric Duct  
CLE, COL, TOL



**Flexmaster U.S.A.**  
Insulated, Acoustic and Non-  
Insulated Flexible Duct, Sheet  
Metal Fittings  
CLE, COL, TOL



**Lennox**  
2-50 ton packaged RTU,  
Rooftop Units, VRF, Mini  
Splits  
CLE, TOL



**Macro Air**  
Large diameter fans 8'-24' for  
Commercial & Industrial, Evenly  
Disputes Heated & Cooled Air  
CLE, COL, TOL



**Metal-Fab Flue Pipe**  
Positive Pressure Boiler Flue, Type "B" Flue,  
AL29-4C Super-High-Ferriitic Flue for Con-  
densing Boilers, & Prefabricated Insulated  
Kitchen Grease Duct Systems  
CLE, COL, TOL



**Powered Aire Inc.**  
Commercial & Industrial  
Air Curtains  
CLE, COL, TOL



**Thermaduct**  
Pre-insulated outdoor duct, The  
Future of Outdoor Duct  
CLE, COL, TOL





**Accurex**  
Kitchen Ventilation Systems  
CLE, COL, TOL



**American Aldes**  
Ventilation and Air Flow  
Products  
CLE, COL, TOL



**Broan**  
Ceiling exhaust fans  
CLE, COL, TOL



**Car-mon Products**  
Vehicle exhaust, source  
Capture  
CLE



**Denlar Fire Protection**  
Commercial Style Fire Suppression for Residential Grade Appliances  
CLE, COL, TOL



**Advanced Radiant Systems**  
Gas fired radiant heaters  
CLE, COL, TOL



**Eaton**  
Variable frequency drives  
CLE, TOL



**Fantech**  
Inline fans; dryer exhaust  
CLE, COL, TOL



**Kees**  
Security Grilles & Barriers, Stamped  
Architectural Grilles, Stainless Steel  
Diffusers & Registers, Air Blenders  
CLE, COL, TOL



**Metropolitan Air Technology**  
Cable and battery operated  
dampers  
CLE, COL, TOL



**Melink**  
Variable volume kitchen  
exhaust systems  
CLE, COL, TOL



**Neptronic**  
Humidifiers, controls, actuators  
CLE, TOL



**Antec Controls**  
Laboratory and Healthcare  
Control Solutions.  
CLE, COL, TOL



**Gripple**  
Range of Hangers for  
HVAC Applications  
CLE, COL, TOL



**Air Concepts**  
Architectural air concepts,  
Specialty Air Distribution  
CLE, COL, TOL



**FRP Solutions**  
FRP Underground  
Ductwork  
CLE, COL, TOL



**Tjernlund Products, Inc.**  
Flue venting, dryer exhaust systems  
CLE, COL, TOL



**Titan**  
Custom Make-up Air, HVAC  
Equipment  
CLE, TOL



**USA Coil & Air**  
New and Replacement Coils  
CLE, COL



# Air Control Products, Inc.

www.aircontrolproducts.com



*Air Control Products and USA Coil & Air have partnered together for over 30 years on being your replacement coil solution.*

- Countless replacement coil designs and arrangement have been built by USA Coil.
- We offer a quick build program on a 5 or 10 working day delivery.
- We have a coil replacement guide that simplifies the process.
- Let ACP show you...Contact your ACP Salesperson or Janet...440-526-3020.



www.usacoil.com

**DON'T FORGET FREEZE PROTECTION**



**Protect your building with Sentry-Guard  
freeze protection on outside air coils...  
Guaranteed!**

## How can we help?

Fax: 440-526-0503

Call: 440-526-3020 ask for your ACP salesperson or Janet

E-mail: [janet@aircontrolproducts.com](mailto:janet@aircontrolproducts.com)

- I would like  Measuring Guide
- Measuring Manual
- Sentry Guard Freeze Brochure Needed
- Need assistance with replacement coil

Company Name: \_\_\_\_\_

Your Name: \_\_\_\_\_

Phone Number: \_\_\_\_\_

e-mail Address: \_\_\_\_\_

# Coil Ordering Form

COMPANY NAME:  
 CONTACT:  
 PHONE:  
 FAX:  
 PROJECT:  
 DATE:

\* REQUIRED FOR PRICING ANY COIL.  
 ADDITIONAL INFORMATION  
 WILL BE REQUIRED TO ACCURATELY  
 BUILD COIL.  
**FORM # CC-100**

NOMENCLATURE		UNIT OR COIL INFORMATION			ARRANGEMENTS		ROWS/FPI
ITEM #	QTY.	(1) ORIGINAL MANUFACTURER UNIT MODEL #	(1-A) ORIGINAL MANUFACTURER COIL MODEL #	* (1-B) COIL TYPE	(2) COIL ARRGT	(3) CONN ARRGT	* (5) ROWS * (6) FPI

NOM.	ITEM #	INTERIOR AND EXTERIOR DIMENSIONS								CONNECTION SIZES AND LOCATIONS							
		* (7) FH X FL	(8) CH X CL X CD	(9) OLH	(10) A	(11) B	(12) C	(12) D	(13) SUPPLY	(13) RETURN	(14) X	(14) Y	(15) Z	(16) TYPE			

NOM.	ITEM #	CONSTRUCTION									
		* (17) TUBE OUTSIDE DIA.	* (18) TUBE MATERIAL	* (19) FIN MATERIAL	(20) HEADER MATERIAL	(21) CONNECTIONS TYPE/MATERIAL	* (22) CASING GAUGE/MATERIAL	(23) COIL CIRCUITRY			

SPECIAL/REMARKS  
 \_\_\_\_\_  
 \_\_\_\_\_  
 \_\_\_\_\_



# How to field measure coils for replacement.

**Below is a step-by-step description of all the steps required to accurately measure any coil for replacement. Please note that there are only 8 to 10 key components required to duplicate any coil. Also note that each step # below matches the corresponding # on Form CC-100.**

**USA offers a "Coil Sidekick" which is a tool that helps you measure several of these key dimensions. Please ask your local representative for one of these, or contact USA Coil & Air directly at 800-872-2645.**

- (1) Determine coil type: Hot water, chilled water, steam, DX, condenser. If you are looking at a non-freeze steam coil, then you should refer to Dwg. #RSD-400. If you are looking at any water coil, then you should refer to Dwg. #RW-200, etc.
- (2) Stand on the entering or leaving air side of the coil (it doesn't matter which side you choose), and match up the coil that you are looking at to the appropriate lettered drawing. For example: a same end connected non-freeze coil would be Dwg.#"A", and an opposite end connected steam coil would be Dwg.#"C".
- (3) Walk around to the connection end of the coil, so that the connections are pointing directly at you. Match up the connection arrangement on the bottom of the drawing. For example: a same end coil being supplied in the middle and returned on the bottom of the same header would be connection arrangement #1. Circle or put an arrow next to the configuration that you are replacing.
- (4) Once you have noted what the coil looks like on the drawing, go to form #CC-100 and fill in the appropriate coil arrangement and connection arrangement under the proper columns marked #'s 2 and 3.
- (5) Count the number of rows deep in the direction of airflow from front to back. An appropriate number would be anywhere from 1 thru 10 rows.
- (6) Count the number of fins/inch. Place a ruler on the fins and count the number of fins in any inch.
- (7) Measure the finned area of the coil. This is the actual "open" area that the air passes across.
- (8) Most coils have some kind of casing around the finned area. This is the "envelope" dimensions of the coil. "CH" is the overall casing height, "CL" is the overall casing length, and "CD" is the overall casing depth.
- (9) The "OLH" dimension is the overall length to include the manifolds and the return bends, which often stick out beyond the casing. Do not include the length of the connection stubs, as they will be measured later. Fill in the "OLH" dimension under column #9.
- (10) Dimension "A" is the stub length. It can vary from 1" long to 8" long. This is not the diameter.
- (11) "B" is the width of the casing on both the top and bottom of the coil. They are usually the same dimension. Fill in "B" under column #11.
- (12) "C" and "D" are the widths of the casing on each end of the coil.
- (13) Measure the I.D. of the coil connections, and this will give you the proper supply and return connection size. Please note that the supply size and return size can be the same or different.
- (14) "X", "Y", position the connections properly for direct replacement, so you don't have to change the piping. Both "X" and "Y" are measured from the top and/or bottom of the casing to the centerline of the connection. Don't measure from the top or bottom of the header, because there is no guarantee that the header runs to the top or bottom of the coil.
- (15) "Z" is the horizontal centerline between the (2) headers, if the coil is same end connected. Measure from the centerline of one header to the centerline of the other header.
- (16) Connection type is either: Sweat, M.P.T., F.P.T.
- (17) Tube outside diameter is either: 3/8", 1/2", 5/8", 7/8", or "1".
- (18) Tube material is either: Copper, Aluminum, Cupro-Nickel, Brass, Steel or Stainless Steel.
- (19) Fin material is either: Aluminum, Copper, Steel or Stainless Steel.
- (20) Header material usually matches tube material. It is possible to have steel headers with different material tubes.
- (21) Connections can be Copper, Steel, Cupro-nickel, Brass or even Aluminum.
- (22) Casing is typically Galv. Steel, Stainless Steel or Aluminum. Gauges run from 18 Ga. to 8 Ga.
- (23) Circuiting is the number of tubes that the supply header feeds. Determine which of the headers is the supply header. Count the number of tubes which are connected to the supply header either visually, or by running your hand down the back of the header and feeling the number of tubes connected to the header. Fill in # of tubes under column #23.

# Standard Steam Heating Coils

STANDARD STEAM HEATING COILS (SINGLE TUBE) • DWG. NO. RSS-300

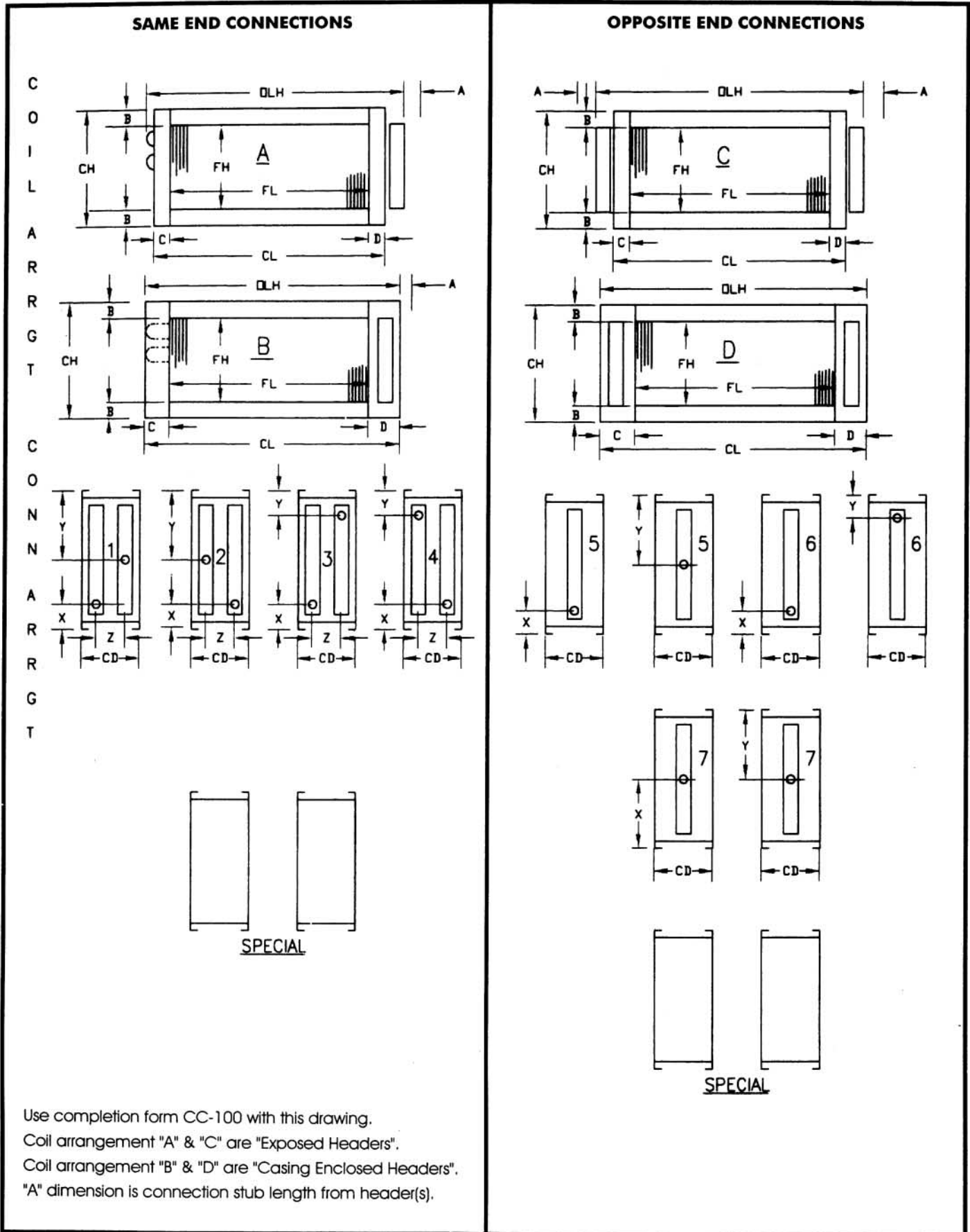

Use completion form CC-100 with this drawing.  
 Coil arrangement "A" & "C" are "Exposed Headers".  
 Coil arrangement "B" & "D" are "Casing Enclosed Headers".  
 "A" dimension is connection stub length from header(s).

# Water Heating & Cooling Coils

WATER HEATING & COOLING COILS • DWG. NO. RW-200

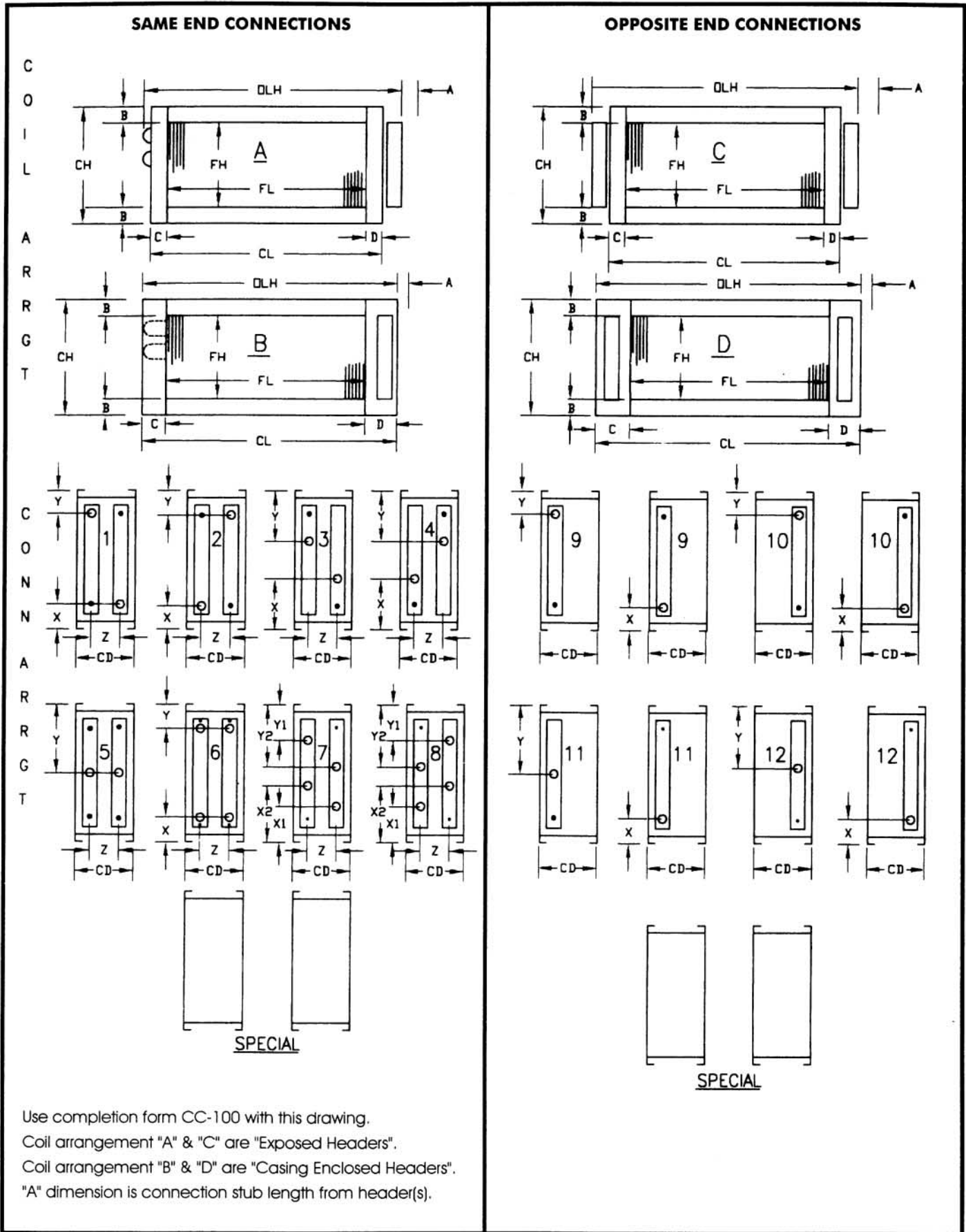

Use completion form CC-100 with this drawing.  
 Coil arrangement "A" & "C" are "Exposed Headers".  
 Coil arrangement "B" & "D" are "Casing Enclosed Headers".  
 "A" dimension is connection stub length from header(s).

# DX Evaporator Coils

## DX EVAPORATOR COILS (WITH DISTRIBUTOR(S)) • RDX-500

### COIL ARRANGEMENT

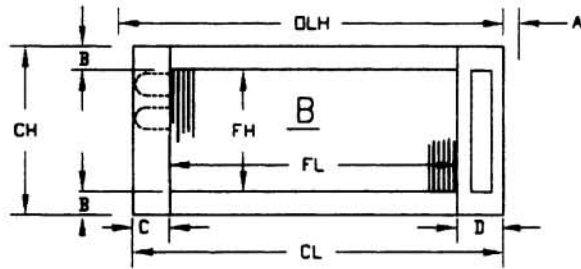
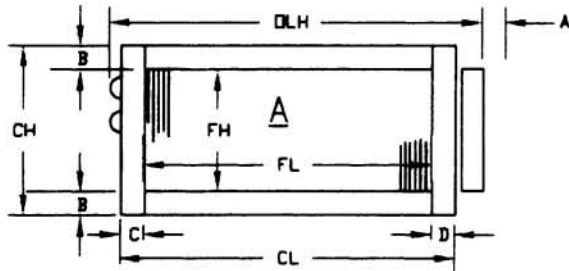

### CONNECTION ARRANGEMENT

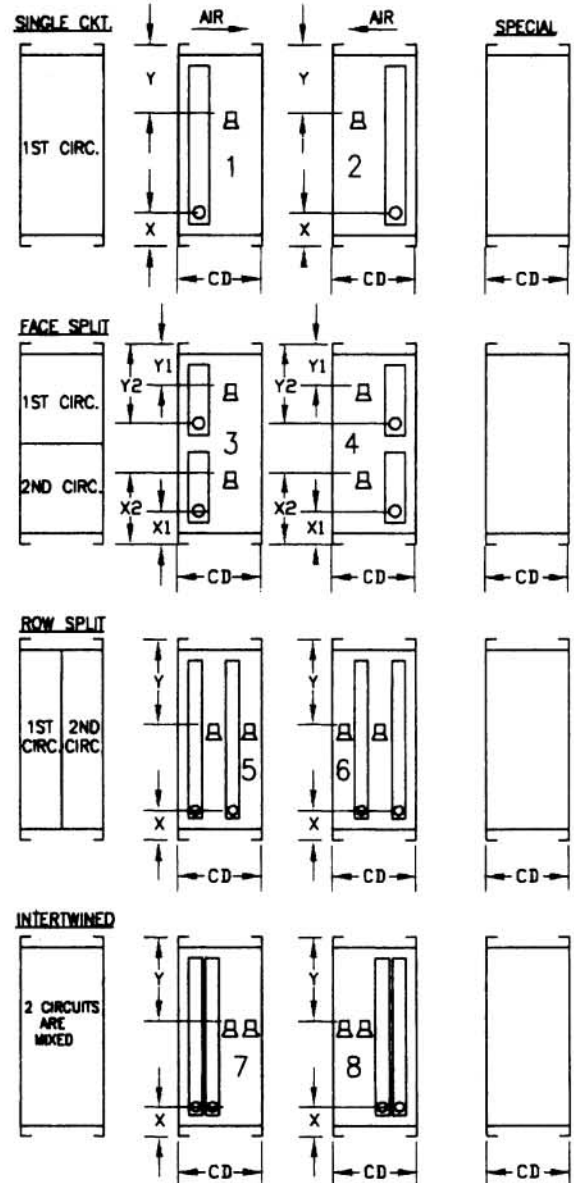

Use completion form CC-100 with this drawing.  
 Coil arrangement "A" & "C" are "Exposed Headers".  
 Coil arrangement "B" & "D" are "Casing Enclosed Headers".  
 "A" dimension is connection stub length from header(s).



# Condenser Coils

Air Control Products, Inc.  
 3800 Towpath Road  
 Cleveland, Ohio 44147  
 (P) 440-526-3020 (F) 440-526-0503  
 www.aircontrolproducts.com

## CONDENSER COILS • DWG. NO. RCC-600

### #1 COIL ARRANGEMENT & BASIC DIMENSIONS

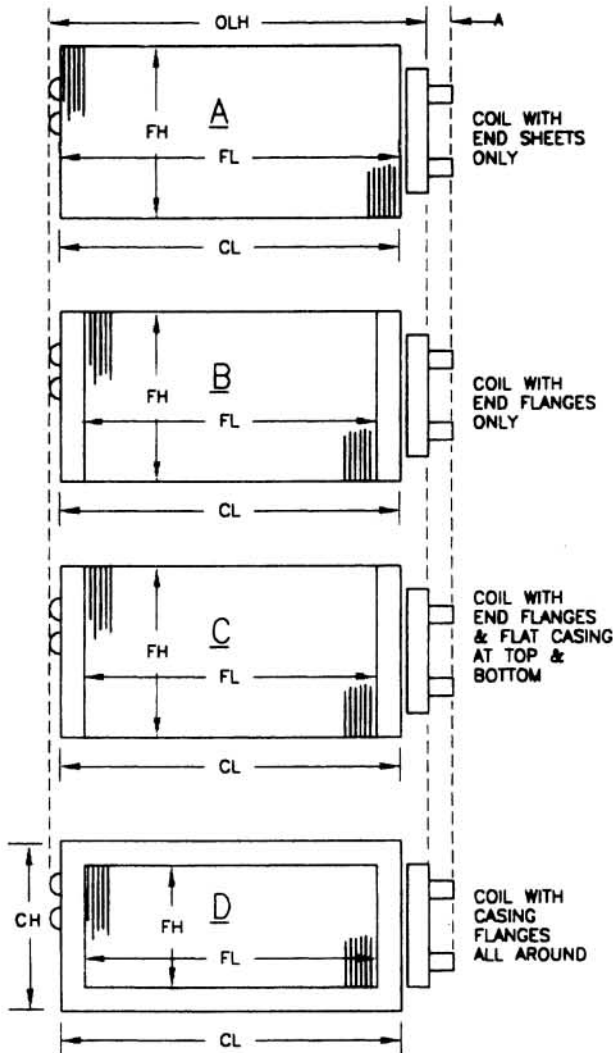

#### #1 Directions

- Select coil arrangement "A" thru "D".
  - Measure FH, FL, CH (if required), CL and OLH (overall length including headers) and "A" (conn. stub length) if connections run same direction as tubes. (Connections can run 90 degree to tube direction.)
  - Record rows, FPI.
  - Record connection size (usually O.D. sweat).
- Use Completion Form CC-100 with this drawing.

### #2 DEFINING CASING DEPTH & CONNECTION LOCATIONS

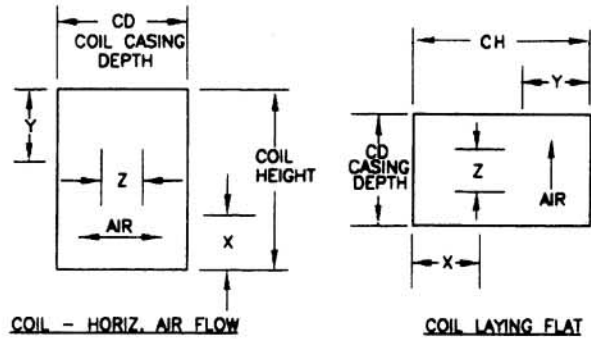

#### #2 Directions

- Measure "CD" dimension (casing depth).
- Measure "X" dimension - from very bottom of coil (or side if coil lays flat) to center line of lowest coil connection.
- Measure "Y" dimension from top to center line (or side if coil lays flat).
- Measure center line between connections "Z".

#### #3 Defining a coil's circuitry.

(Return bends, header, etc. is confusing.) USA gives you two options as follows:

##### OPTION #1

Take complete photos of the end view of coil at both ends. Make sure that it is well lighted and that you get the whole end view from one end (top to bottom) to other. If you need to take multiple shots USA will be able to put them together. Try to put them at a slight angle to headers so we can see the tube connection to the headers.

##### OPTION #2

Supply this drawing with completion form and supply the following information:

1. Tube O.D. \_\_\_\_\_, NO. of tubes high in single row of tubes \_\_\_\_\_, NO. of tubes connected to hot gas inlet header \_\_\_\_\_, NO. of tubes connected to liquid outlet \_\_\_\_\_, Unit tonnage \_\_\_\_\_, NO. of cond. coils in unit \_\_\_\_\_.